

Optimo 60L



FR

NL

DE

EN

ES

IT

PT

TH

MS

ZH

AR

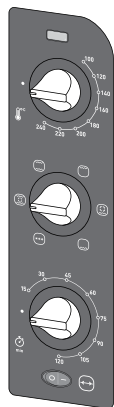
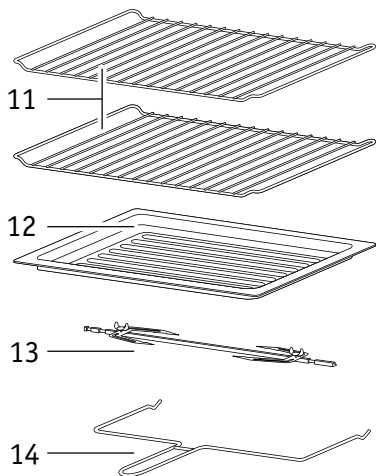
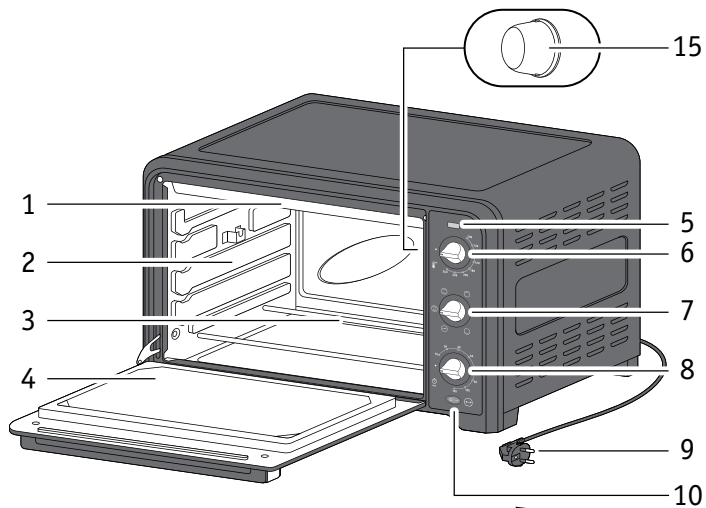

DESCRIPTION

- 1 Résistance supérieure
- 2 Parois aluminium
- 3 Résistance inférieure
- 4 Porte double parois
- 5 Indicateur lumineux d'alimentation
- 6 Bouton de contrôle de la température
- 7 Bouton des fonctions
- 8 Bouton du minuteur

BESCHRIJVING

- 1 Bovenste verwarmingselement
- 2 Aluminium wanden
- 3 Onderste verwarmingselement
- 4 Dubbelwandige deur
- 5 Aan/uit-controlelampje
- 6 Temperatuurregelaar
- 7 Functieknop
- 8 Timerknop

BESCHREIBUNG

- 1 Oberes Heizelement
- 2 Aluminiumwände
- 3 Unteres Heizelement
- 4 Doppelwandige Tür
- 5 Betriebskontrollleuchte
- 6 Temperaturregler
- 7 Funktionsknopf
- 8 Timer-Knopf

DESCRIPTION

- 1 Top heating element
- 2 Aluminium walls
- 3 Bottom heating element
- 4 Double-wall door
- 5 Power indicator light
- 6 Temperature control knob
- 7 Functions knob
- 8 Timer knob

DESCRIPCIÓN

- 1 Resistencia superior
- 2 Paredes aluminio
- 3 Resistencia inferior
- 4 Puerta de doble cristal
- 5 Indicador luminoso de encendido
- 6 Mando de control de la temperatura
- 7 Mando de funciones
- 8 Mando del temporizador

- 9 Cordon d'alimentation
- 10 Interrupteur de rôtisserie
- 11 Grille réversible
- 12 Plat lèche-frite
- 13 Accessoire tourne-broche
- 14 Poignée support tourne-broche
- 15 Lumière interne

- 9 Snoer
- 10 Draaispitschakelaar
- 11 Omkeerbaar grillrooster
- 12 Ovenschaal
- 13 Draaispit
- 14 Draaispitgreep
- 15 Binnenverlichting

- 9 Netzkabel
- 10 Rotisserie-Schalter
- 11 Umkehrbarer Grillrost
- 12 Backblech
- 13 Grillspieß
- 14 Rotisserie-Griff
- 15 Innenbeleuchtung

- 9 Power cord
- 10 Rotisserie switch
- 11 Reversible grill rack
- 12 Food tray
- 13 Rotisserie
- 14 Rotisserie handle
- 15 Inner light

- 9 Cable de alimentación
- 10 Interruptor del asador
- 11 Parrilla de grill reversible
- 12 Bandeja de comida
- 13 Asador
- 14 Mango del asador
- 15 Luz interior

DESCRIZIONE

- 1 Elemento riscaldante superiore
- 2 Pareti in alluminio
- 3 Elemento riscaldante inferiore
- 4 Porta a doppia parete
- 5 Spia di accensione
- 6 Manopola del termostato
- 7 Manopola funzioni
- 8 Manopola timer

DESCRIÇÃO

- 1 Resistência superior
- 2 Paredes alumínio
- 3 Resistência inferior
- 4 Porta de parede dupla
- 5 Indicador luminoso de energia
- 6 Botão de controlo da temperatura
- 7 Botão das funções
- 8 Botão do temporizador

คำอธิบาย

- 1 ส่วนทำความร้อนด้านบน
- 2 ผนังอลูมิเนียม
- 3 ส่วนทำความร้อนด้านล่าง
- 4 ฝาเปิด 2 ชั้น
- 5 ไฟสัญญาณพลังงาน
- 6 ลูกบิดควบคุมอุณหภูมิ
- 7 ลูกบิดปรับฟังก์ชัน
- 8 ลูกบิดตั้งเวลา

PENERANGAN

- 1 Elemen pemanasan atasan
- 2 Dinding aluminium
- 3 Elemen pemanasan bawahan
- 4 Pintu dinding-berganda
- 5 Lampu penunjuk kuasa
- 6 Tombol kawalan suhu
- 7 Tombol fungsi
- 8 Tombol masa

說明

- 1 上發熱線
- 2 鍍鋁內膽
- 3 下發熱線
- 4 雙層門
- 5 電源指示燈
- 6 溫度控制旋鈕
- 7 功能旋鈕
- 8 時間旋鈕

الوصف

- 9 سلك الطاقة
- 10 محول المشواة
- 11 حامل المشواة القابل للعكس
- 12 صينية الطعام المشواة
- 13 مسكة المشواة
- 14 الضوء الداخلي

- 9 Interruttore girarresto
- 10 Spia di alimentazione
- 11 Griglia di cottura reversibile
- 12 Vassoio degli alimenti
- 13 Girarresto
- 14 Manico girarresto
- 15 Luce interna

- 9 Interruptor do espeto
- 10 Luz piloto de funcionamento
- 11 Grelha reversível
- 12 Tabuleiro
- 13 Espeto
- 14 Pega do espeto
- 15 Luz interior

- 9 สายไฟ
- 10 สวิตช์ไม่เสียบหมน
- 11 ตะแกรงแบบพลิกกลับได้
- 12 ถาดอาหาร
- 13 ไม้เสียบหมน
- 14 ที่จับไม้เสียบหมน
- 15 แสงไฟภายใน

- 9 Kabel kuasa
- 10 Suis rotisserie
- 11 Rak gril boleh balik
- 12 Dulang makanan
- 13 Rotisserie
- 14 Pemegang rotisserie
- 15 Lampu dalaman

- 9 電源線
- 10 旋轉烤架開關
- 11 可逆燒烤架
- 12 食物托盤
- 13 旋轉烤架
- 14 旋轉烤架把手
- 15 內部照明燈

- 1 عنصر التسخين العلوي
- 2 جدران الألومنيوم
- 3 عنصر التسخين السفلي
- 4 باب مزدوج الجدار
- 5 ضوء مؤشر الطاقة
- 6 مقبض التحكم في درجة الحرارة
- 7 مقبض الوظائف
- 8 مقبض الموقت

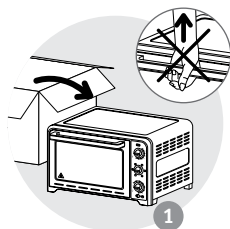
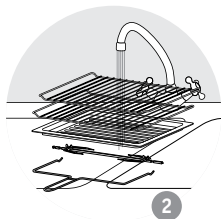
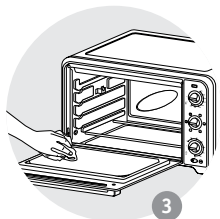
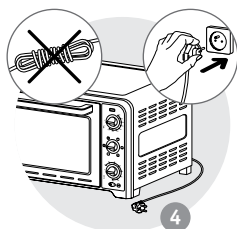
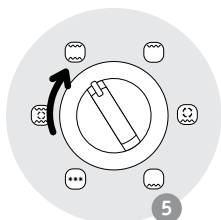
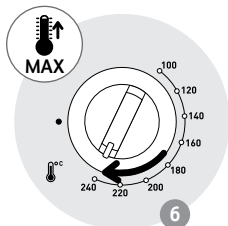
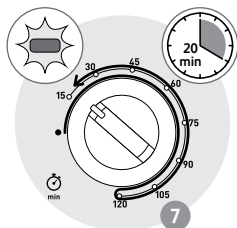
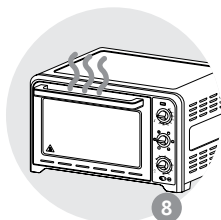
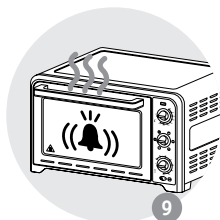
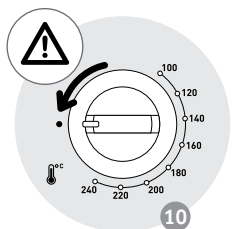
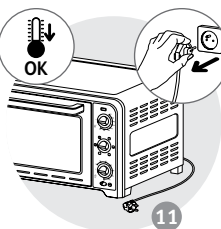
1**1****2****3****4****5****6****7****8****9****10****11**

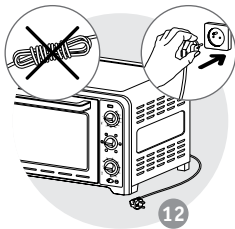

12

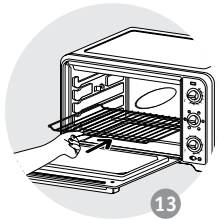

13

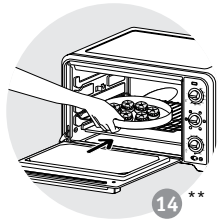

14 **

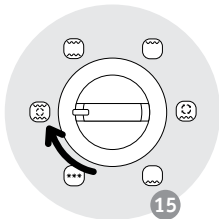

15

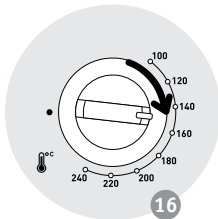

16

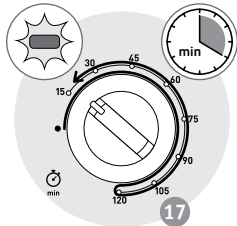

17

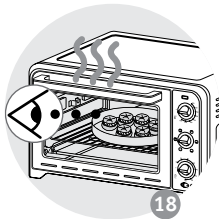

18

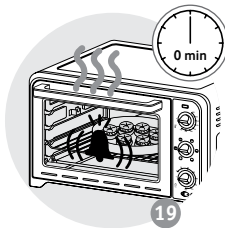

19

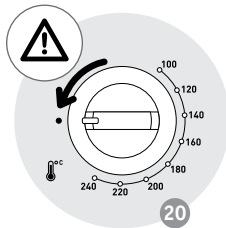

20

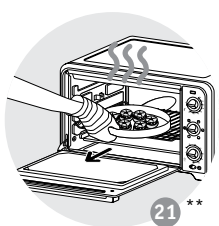

21 **

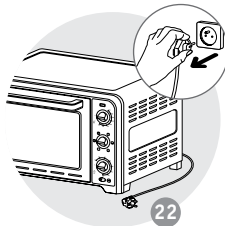

22

** Plat non fourni avec l'appareil
 Schaaf niet bij het apparaat inbegrepen
 Platte nicht im Lieferumfang inbegriffen
 The dish is not supplied with the appliance
 El plato no es suministrado con el aparato
 Piatto non fornito con l'apparecchio
 Travessa não fornecida com o aparelho
 เครื่องนี้ไม่ได้มาพร้อมจาน
 Makanan tidak disertakan dengan alat perkakas
 焗爐不隨附碟子

** الصحن غير مرفق مع الجهاز

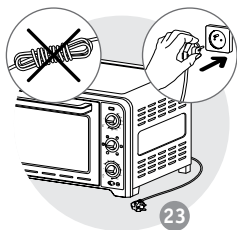

23

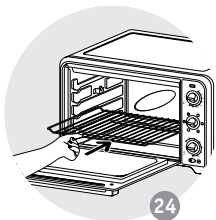

24

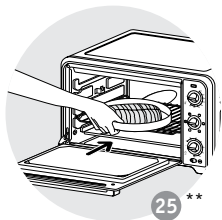

25 **

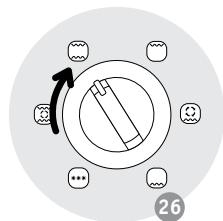

26

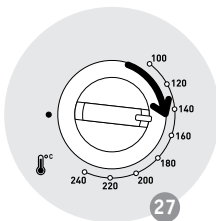

27

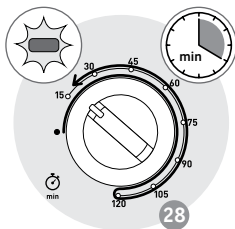

28

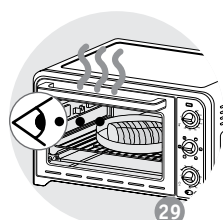

29

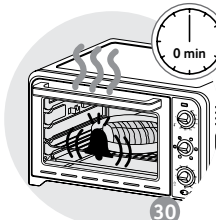

30

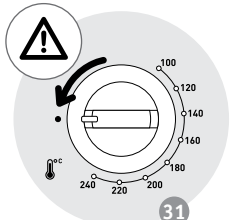

31

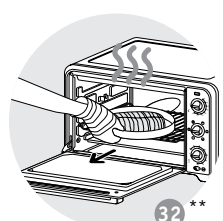

32 **

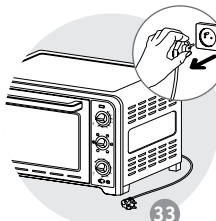

33

** Plat non fourni avec l'appareil
 Schaaf niet bij het apparaat inbegrepen
 Platte nicht im Lieferumfang inbegriffen
 The dish is not supplied with the appliance
 El plato no es suministrado con el aparato
 Piatto non fornito con l'apparecchio
 Travessa não fornecida com o aparelho
 เครื่องนี้ไม่ได้มาพร้อมจาน
 Makanan tidak disertakan dengan alat perkakas
 焗爐不隨附碟子

** الصحن غير مرفق مع الجهاز

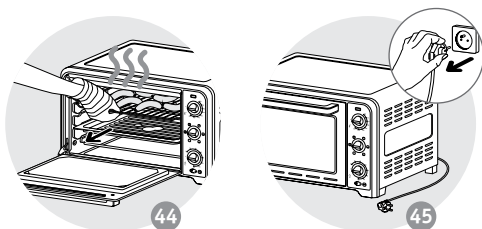
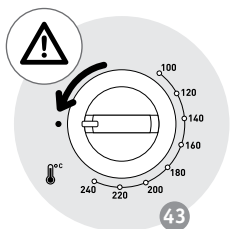
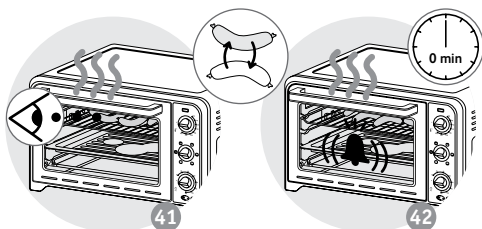
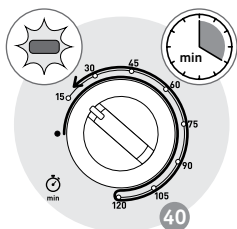
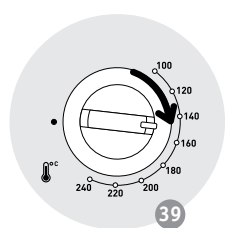
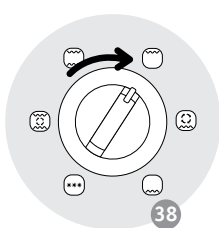
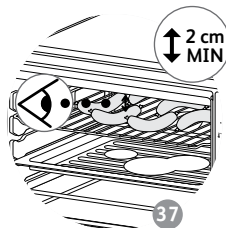
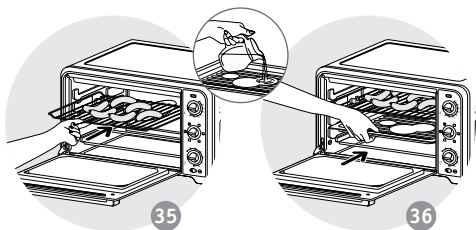
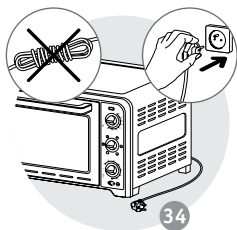

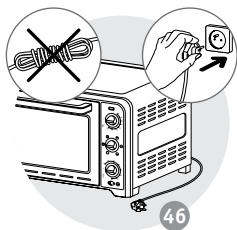

46

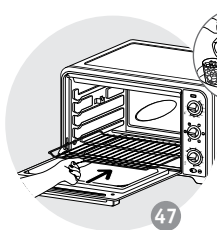

47

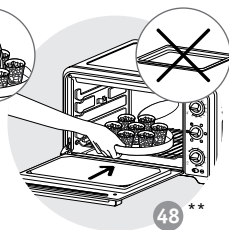

48 **

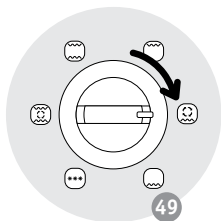

49

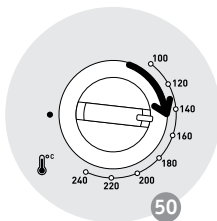

50

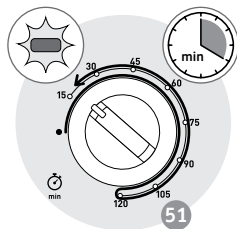

51

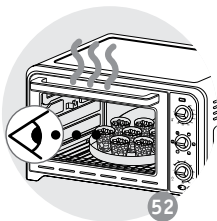

52

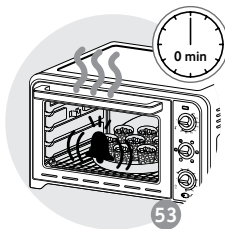

53

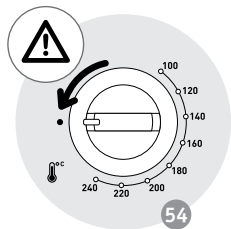

54

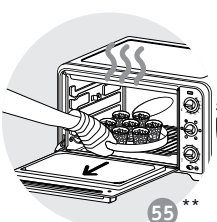

55 **

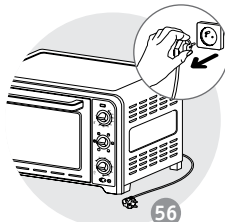

56

** Plat non fourni avec l'appareil
 Schaal niet bij het apparaat inbegrepen
 Platte nicht im Lieferumfang inbegriffen
 The dish is not supplied with the appliance
 El plato no es suministrado con el aparato
 Piatto non fornito con l'apparecchio
 Travessa não fornecida com o aparelho
 เครื่องนี้ไม่ได้มาพร้อมจาน
 Makanan tidak disertakan dengan alat perkakas
 焗爐不隨附碟子

** الصحن غير مرفق مع الجهاز

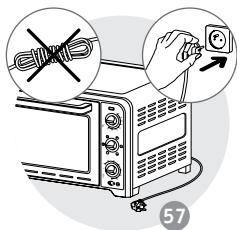

57

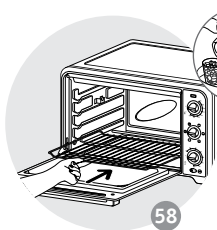

58

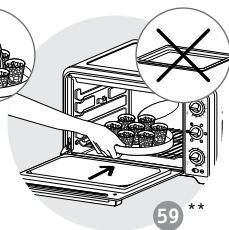

59 **

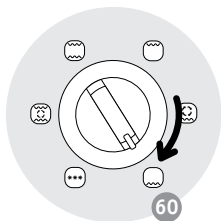

60

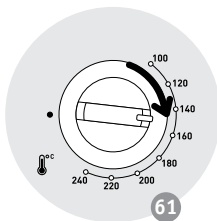

61

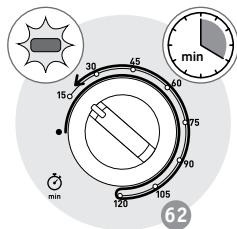

62

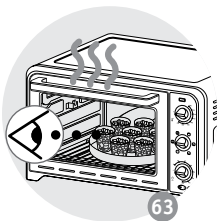

63

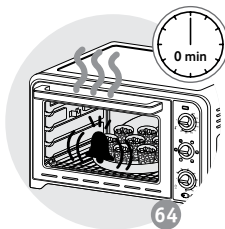

64

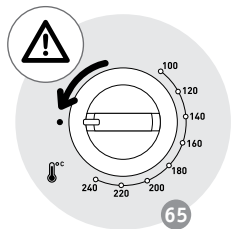

65

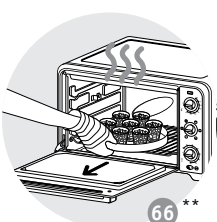

66 **

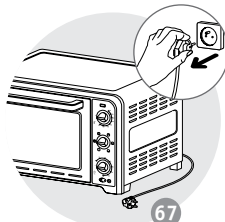

67

** Plat non fourni avec l'appareil
 Schaaf niet bij het apparaat inbegrepen
 Platte nicht im Lieferumfang inbegriffen
 The dish is not supplied with the appliance
 El plato no es suministrado con el aparato
 Piatto non fornito con l'apparecchio
 Travessa não fornecida com o aparelho
 เครื่องนี้ไม่ได้มาพร้อมจาน
 Makanan tidak disertakan dengan alat perkakas
 焗爐不隨附碟子

** الصحن غير مرفق مع الجهاز

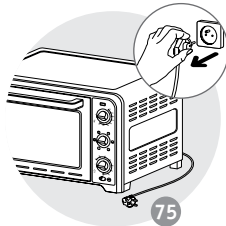
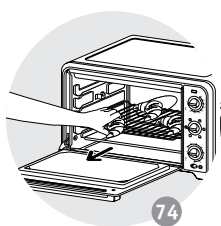
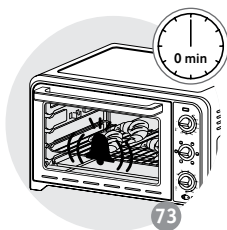
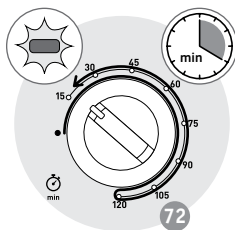
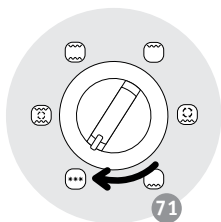
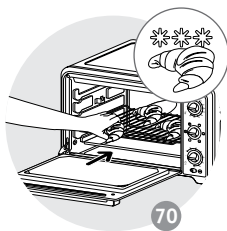
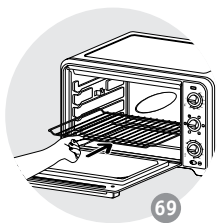
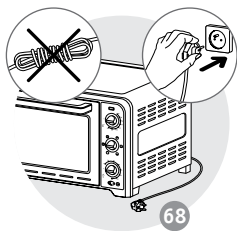

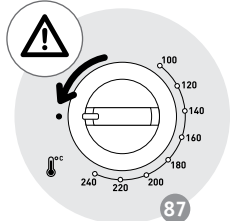
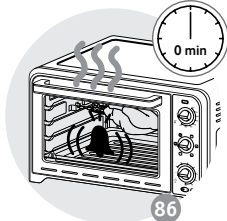
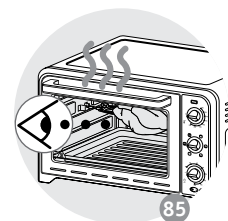
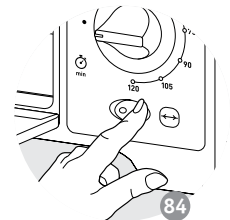
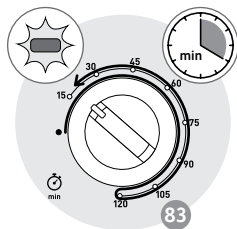
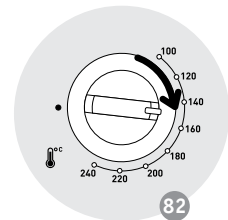
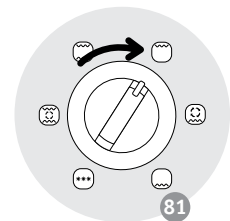
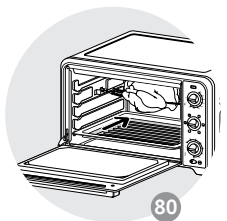
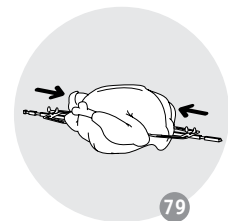
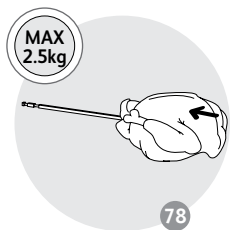
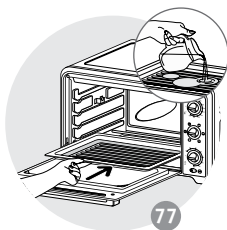
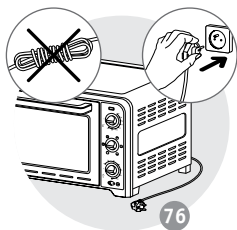

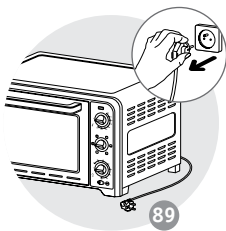
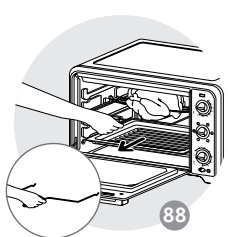



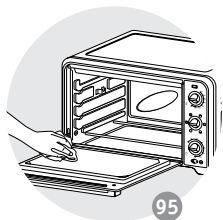
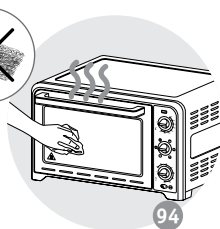
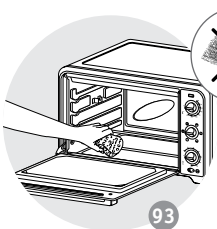
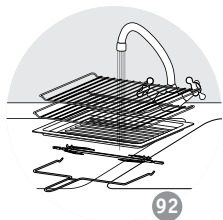
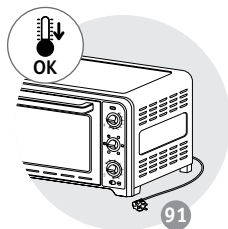
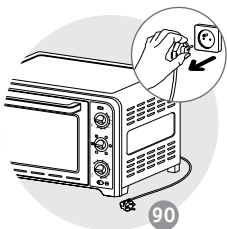



















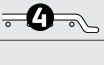



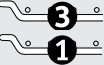





9



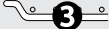

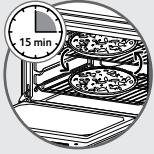
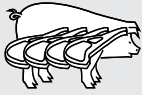
						min
	x 8			10 min دقائق	240	20
	1,5 Kg كيلو غرام			10 min دقائق	240	65
	1,5 Kg كيلو غرام			10 min دقائق	240	45
	1,5 Kg كيلو غرام			10 min دقائق	240	90
	x 8			-	240	24 ↻ +9
	x 12			-	240	15 ↻ +5
	400 gr غرام			10 min دقائق	220	25
				10 min دقائق	240	45
	650 gr غرام			10 min دقائق	230	30
				-	240	40
				10 min دقائق	200	45
				10 min دقائق	200	25
				-	140	35
				10 min دقائق	230	45
				10 min دقائق	240	30
	2 Kg كيلو غرام			-	240	80
	x 6			10 min دقائق	240	22

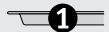
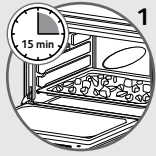
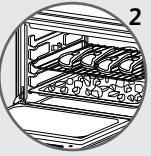
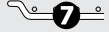
						 min
	1.0 Kg کیلو غرام			-	240	60
						
	2x 1.0 Kg کیلو غرام			-	240	40
	2x 4		 	-	240	15  +8
	400 g گرام		 	-	220	35
	x 4					

						
	2x 400 gr گرام		 3	10 min دقائق	230	15  10
						
 	x 4		 1	-	240	15
			 15 min	 2		
	1 Kg كيلو غرام		 7	-	240	+25
			 1			



Pour les plats pesant plus de 4,5 kg, veuillez toujours utiliser la grille réversible dans cette position.

Voor gerechten boven 4,5 kg, gebruik het omkeerbaar rooster altijd in deze positie.

Bitte benutzen Sie bei Speisen über 4,5 kg den umkehrbaren Grillrost in dieser Position.

For dishes above 4.5 kg, please always use the reversible grid in this position.

Para platos que pesen más de 4,5 kg, utilice siempre la parrilla reversible en esta posición.

Per piatti superiori a 4,5 kg, utilizzare sempre la griglia reversibile in questa posizione.

Para pratos com mais de 4,5 kg, use sempre a grelha reversível nesta posição.

สำหรับจานที่หนักกว่า 4.5 กก. กรุณาใช้ตะแกรงแบบพลิกกลับได้ในตำแหน่งนี้ทุกครั้ง

Untuk makanan lebih dari 4.5kg, sentiasa gunakan grid boleh balik dalam kedudukan ini.

當重於4.5公斤，請將兩面用網架放成這個方位。

للأطباق التي يزيد وزنها عن 4,5 كيلو غرام، يرجى دائما استخدام الشبكة القابلة للعكس في هذه الموضعية.



96

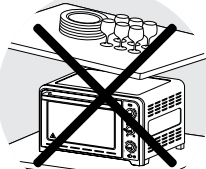

97



98

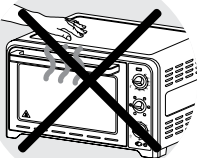

99



100

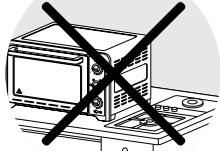

101

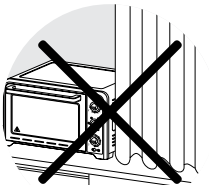

102

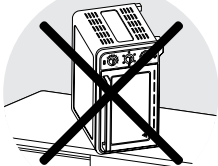

103

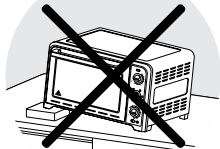

104



105

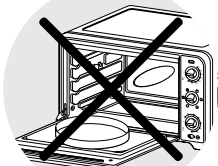

106

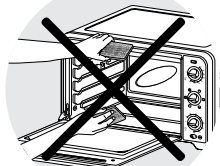

107

