



INTUOS[®] pro



User's manual

Intuos Pro (PTH-451, PTH-651, PTH-851)

[Setting up Intuos Pro](#)

[Using the Pen](#)

[Tablet controls](#)

[The Intuos pro multi-touch experience](#)

[Customizing Intuos pro](#)

[Application-specific settings](#)

[Working with multiple tools](#)

[Going wireless with Intuos pro](#)

[Troubleshooting](#)

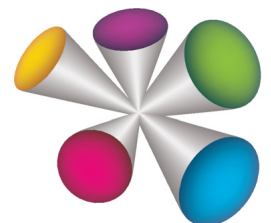



Intuos pro

User's Manual

Version 1.0, Rev J3113

Copyright © Wacom Co., Ltd., 2013

All rights reserved. No part of this manual may be reproduced except for your express personal use.

Wacom reserves the right to revise this publication without obligation to provide notification of such changes.

Wacom does its best to provide current and accurate information in this manual. However, Wacom reserves the right to change any specifications and product configurations at its discretion, without prior notice and without obligation to include such changes in this manual.

The above year indicates when this manual was prepared. However, the date of release to the users of the "manual" is simultaneous with the introduction into the market of the applicable Wacom product.

Intuos and Wacom are registered trademarks of Wacom Co., Ltd.

Adobe and Photoshop are either registered trademarks or trademarks of Adobe Systems Incorporated in the United States and/or other countries. Microsoft, Windows, and Vista are either registered trademarks or trademarks of Microsoft Corporation in the United States and/or other countries. Apple, the Apple logo, and Mac are registered trademarks of Apple, Inc., registered in the U.S. and other countries.

Any additional company and product names mentioned in this documentation may be trademarked and/or registered as trademarks. Mention of third-party products is for information purposes only and constitutes neither an endorsement nor a recommendation. Wacom assumes no responsibility with regard to the performance or use of these products.

ExpressKey is a registered trademark of Ginsan Industries, Inc., and is used with permission.





TABLE OF CONTENTS

TABLE OF CONTENTS	3	Customizing the Touch Ring	34
ABOUT THE MANUAL	5	Tablet to screen mapping	35
ABOUT YOUR INTUOS PRO TABLET	6	Portion of screen area	37
System requirements	6	Portion of tablet area	38
Intuos Pro tablet	7	Button functions	39
Intuos Pro Pen	9	Working with Display Toggle	47
SETTING UP INTUOS PRO	10	Application-specific settings	49
Connecting Intuos Pro to your computer	10	Creating an application-specific setting	50
USB cable installation	10	Removing application-specific settings	50
Installing the driver	11	Working with multiple tools	51
Configuring the tablet orientation	12	Changing the tablet mode	51
The tablet active area	13	Advanced options	52
Working with multiple monitors	14	Managing preferences	53
Control panel overview	14	GOING WIRELESS WITH INTUOS PRO	54
USING INTUOS PRO	15	Wireless accessory components	54
Setting up your work area	15	Wireless setup	55
Using the Pen	15	Establishing a wireless connection	56
Holding the pen	16	Optimizing the wireless connection	57
Positioning	17	Battery and power management	58
Clicking	17	Charging the battery	58
Erasing	17	Battery and wireless connection status	59
Dragging	17	Power saving features	60
Working with Tilt	17	Battery life information	61
Working with pressure sensitivity	17	Battery replacement	62
Using the side switch	18	Wireless module removal	63
Tablet controls	18	Wireless receiver storage	63
Application-specific Expresskey defaults	19	Testing the wireless connection	64
Using the Expresskey display	20	TROUBLESHOOTING	65
Using the Touch Ring	21	Testing your tablet	66
Control panel	22	Testing the tablet controls and tools	68
THE INTUOS PRO MULTI-TOUCH EXPERIENCE	24	Testing the ExpressKeys	69
Navigating with touch	25	Testing the Touch Ring	69
Setting the touch options	26	Testing a pen	70
Choosing custom touch functions	27	Troubleshooting tables	71
CUSTOMIZING INTUOS PRO	28	General problems	71
Customizing the pen	29	Pen problems	72
Adjusting tip feel and double-click	30	Touch problems	74
Adjusting eraser feel	31	Wireless connection problems	74
Advanced tip and eraser pressure settings	31	Windows-specific problems	77
Customizing tool buttons	32	Mac-specific problems	78
Customizing the ExpressKeys	33	Technical support options	80
		Obtaining software updates	80
		Care and maintenance	80





APPENDIX	81
Replacing the pen nib	81
Uninstalling Intuos Pro	82
Installing multiple tablets	83
Using integrated applications	83
Importing expert settings	84
Using the optional Airbrush and Art Pen	85
Using the optional mouse	86
Customizing the mouse	87
Testing the mouse	89
Pen and digital ink capabilities in Windows	90
Product information	91
Ordering parts and accessories	91
Warranty Service	92
Warranty Service in the U.S. and Canada	92
Warranty Service Outside of the U.S. and Canada	92
GLOSSARY	93
INDEX	96









ABOUT THE MANUAL

This manual provides quick access to information about your Intuos Pro. The information is common to Windows and Mac computers and Windows screen captures are shown, unless otherwise noted.

- Go directly to [Table of Contents](#) or [Index](#) topics by clicking on them.
- Use the navigation controls to move through the manual.

			Go to front page.
Contents	Go to table of contents.	 	Page back, or page forward.
Index	Go to index.		Go back to previous view.

- Use your .pdf viewer zoom-in tool to increase the size of the manual on your display screen. See the viewer application help for information on any additional tools that help you use and print the manual.
- SMALL CAPITAL LETTERS are used for names of keyboard keys, dialog boxes, and control panel options.
- Be sure to read the Important Product Information document for Intuos, located on the Intuos Pro installation CD. The document includes safety precautions, specifications, and license agreement.
- The following information is not included with this product: information about your specific computer hardware or operating system, or information about your application software. Your best source for this information is the set of manuals and discs that came with your hardware, operating system, or application.
- In addition to the built-in inking support found within Microsoft Windows 8, Windows 7 and Vista, many graphics applications also support pressure sensitivity and the pen eraser. You can find a listing of applications that support these features on the Wacom web site (see [Product information](#)).

Wacom's philosophy is to continually improve all of its products. As a result, engineering changes and improvements are made from time to time. Therefore, some changes, modifications, and improvements may not be covered in this manual.





ABOUT YOUR INTUOS PRO TABLET

This section introduces you to Intuos Pro features and functionality. There are three models of the Intuos Pro. The model number is on the back of your tablet. All models support pen and touch input.

Your Intuos can only be used with a compatible Wacom pen, such as the pen that came with your product, or a Wacom accessory tool specified for use with Intuos. See [Ordering parts and accessories](#).

When you have unpacked your Intuos, make sure that you have received the following items and accessories:

- Intuos Pro tablet
- Pen
- Pen holder with nib storage
- Intuos wireless kit, which includes battery, wireless receiver and module
- Installation CD
- Quick Start Guide (booklet)
- Extra pen nibs
- Nib removal tool
- Pen color rings
- Power cord

SYSTEM REQUIREMENTS

Make sure your computer meets the following minimum system requirements:

- **PC.** Windows 8, Windows 7 or Windows Vista, 32 or 64-bit configurations. One available USB port. A CD-ROM drive is required to install the driver from the Installation CD.
- **Mac.** OS X, v10.6 or later. Intel-based platforms only. One available USB port. A CD-ROM drive is required to install the driver from the Installation CD.

Note: You may also download and install the driver from the Wacom website, for both Windows and Mac operating systems (see [Installing the driver](#)).



INTUOS PRO TABLET

[Touch Ring](#)

Includes the Toggle Button at the center of the ring. Press to:

- Toggle between Touch Ring modes.
- Wake tablet from sleep mode when operating wirelessly.

Status LEDs

- An LED will glow dimly when Intuos Pro is connected to an active USB port.
- An LED will brighten when you touch the active area, or use the pen, Touch Ring or ExpressKeys.
- LEDs also indicate which of the four Touch Ring modes are active.

For wireless operation, see [Battery and wireless connection status](#).

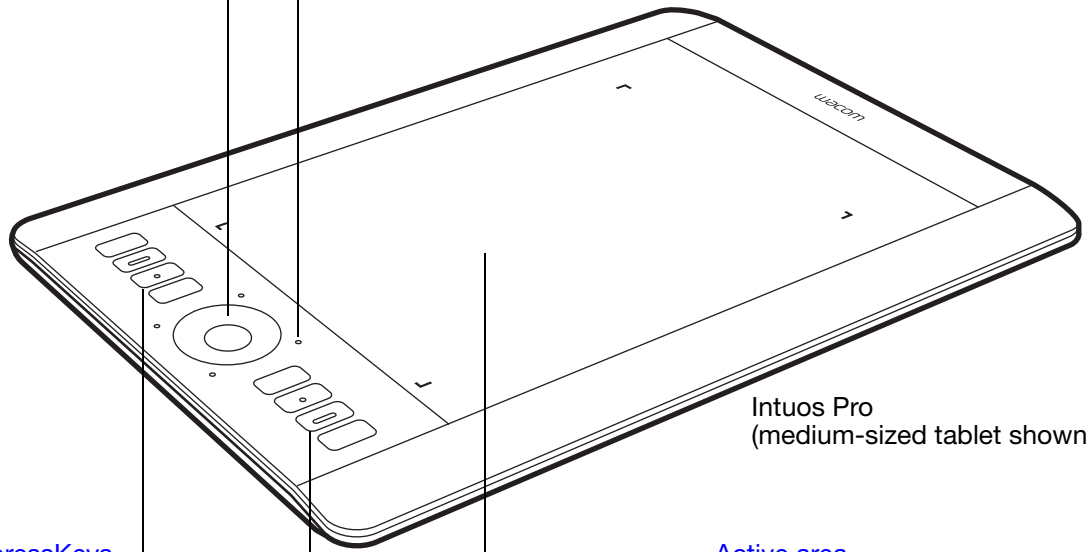

Intuos Pro (medium-sized tablet shown)

Customizable [ExpressKeys](#)

Small Intuos Pro tablets (model PTH-451) have six ExpressKeys.

The ExpressKeys also provide automatic settings for a number of popular applications.

See [Using the Expresskey display](#).

[Active area](#)

Active area markers are used to identify the active area for pen input and touch. Learn about your [Intuos Pro Pen](#) and the [touch experience](#) with Intuos Pro.

To set the brightness level of the active area markers and status LEDs, see [Advanced options](#).

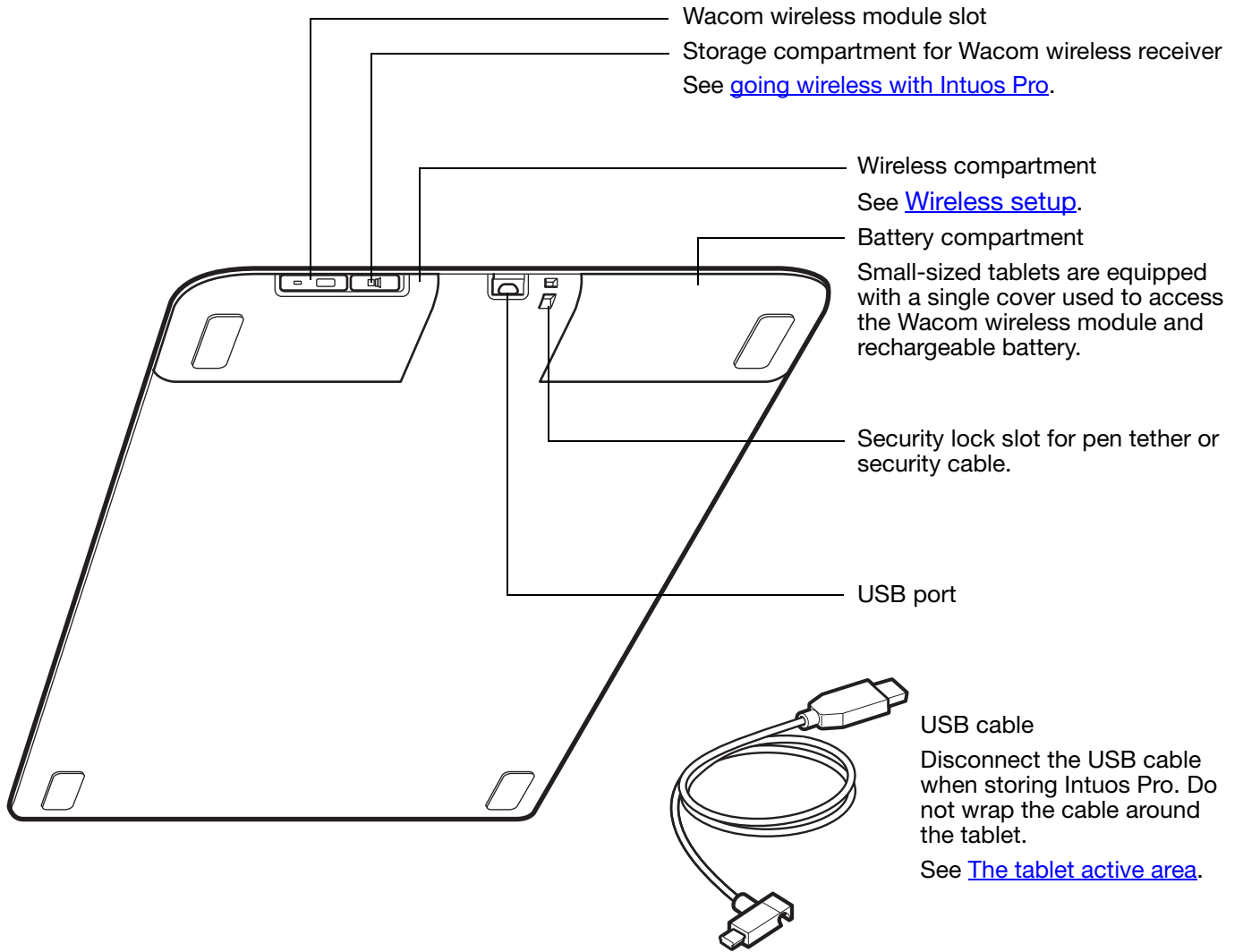

INTUOS PRO PEN

All Intuos Pro Pens are cordless and battery free.

[Eraser](#)

Grip area

[Side switch](#)
(rocker style)

[Replaceable nib](#)
(pen tip)

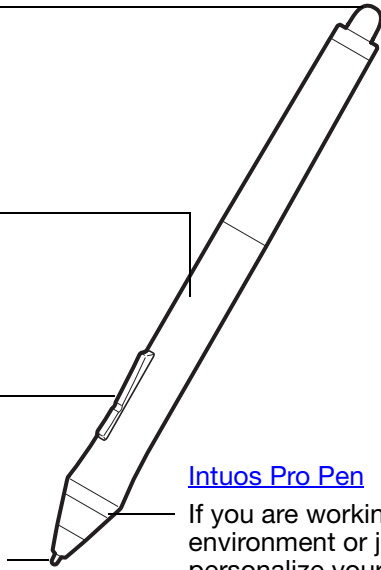

[Intuos Pro Pen](#)

If you are working in a multi-user environment or just want to personalize your pen, unscrew the tip cone and replace the ring with a different color (included).

Colored rings may not be available in all regions.

Pen stand

Unscrew the base to access the nib removal tool and assorted replacement nibs.

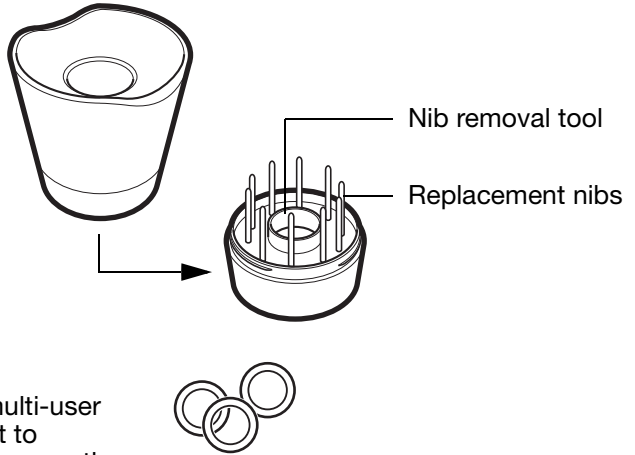

See [Product information](#) to learn more about which applications currently support the special features of your Intuos Pro Pen.

SETTING UP INTUOS PRO

CONNECTING INTUOS PRO TO YOUR COMPUTER

A USB cable for connecting the Intuos pro to your computer is provided.

- Connect the USB cable to the Intuos pro as shown.
- Connect the other end of the cable to a USB port on your computer. When the connection is complete, the Status LEDs will light (white).
- Touch the active area of the Intuos pro with your pen or your finger. The Status LEDs will brighten.

USB CABLE INSTALLATION

1. The USB cable can be connected to suit your preferred handedness.
 - For right-handed use, connect the USB cable to the tablet as is.
 - For left-handed use, make a loose loop and press the cable into the looping clip located on the USB plug.
2. Connect the other end of the cable to your computer.

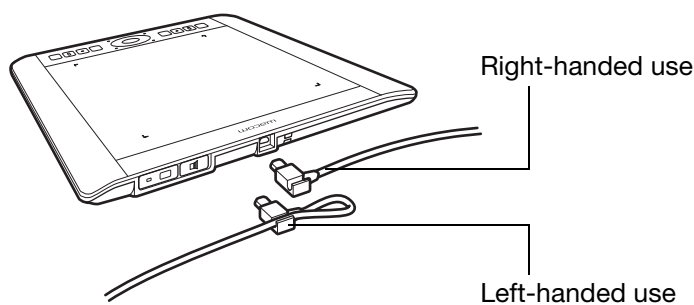

See also [Installing the driver](#).

[The tablet active area](#)

[Control panel overview](#)



INSTALLING THE DRIVER

On Windows systems, the driver installs automatically when the Intuos pro is connected to your computer. The driver is also on the Installation CD, or as a download from the Support area of the Wacom website.

On the Mac, you can install the driver from the CD, or download and install it from the Wacom website.

Note: Your Intuos pro will not work without the driver. Make sure to install the driver to use your tablet.

To install the driver:

1. Save your work and close all open applications.
2. Temporarily disable any virus protection programs.
3. Install the driver:
 - If you are using the Mac, insert the Installation CD into your computer's CD-ROM drive. If the software installer menu does not display, double-click the INSTALL or STARTUP icon located on the CD. You may also download the driver from the Wacom website.
 - On Windows systems, the installation should begin automatically after connection of the Intuos pro. However, you may also install from the CD, or download the driver from the Wacom website.
4. Click INSTALL TABLET and follow the prompts to install the driver software.
5. Reactivate your virus protection program.
6. After completing the software installation, make sure you can use your pen on the Intuos pro to move the screen cursor.

When you place the pen tip on or close to the active area, the cursor should immediately jump to a corresponding position approximately beneath the pen tip. Lift the pen tip and place it in a different location. The screen cursor should again jump to the new position.

7. Check the Notes linked to the driver download page for updated information. Review the Important Product Information document located on the Installation CD for cautions and warnings. If you have trouble installing the driver, see [Troubleshooting](#).

Notes:

User-specific preferences are supported. After logging on, each user can customize their personal settings in the Wacom Tablet control panel. Switching to another user (either by logging on, or user switching methods) will load the settings for that user.

If you lose cursor control, the preferences may be corrupted. See [Managing preferences](#) to delete the current preference settings and return the Intuos pro to its factory default condition.

Driver installation automatically activates the pen input functions available in Microsoft Windows 8 and Windows 7 (except for Windows 7 Starter and Home Basic). See [Pen and digital ink capabilities in Windows](#).

To download a new software driver (when available) from the Internet, see .

To uninstall the software driver, see [Uninstalling Intuos Pro](#).



CONFIGURING THE TABLET ORIENTATION

When you first installed Intuos pro, you were prompted to choose a default tablet orientation. The orientation you chose was used to determine the tablet default settings.

However, you can reconfigure Intuos pro for left- or right-handed users at any time. ExpressKey and Touch Ring settings are automatically reconfigured when you change the handedness setting.

Right-handed operation:

- Open the Wacom Tablet control panel and select the [MAPPING](#) tab. (See [Control panel](#).) Choose the EXPRESSKEYS LEFT orientation option. The tablet driver automatically configures all aspects of the tablet, including the Wacom Tablet control panel options, for correct right-handed use.
- Next, physically rotate your tablet so the tablet ExpressKeys are positioned to the left. See also [The tablet active area](#).

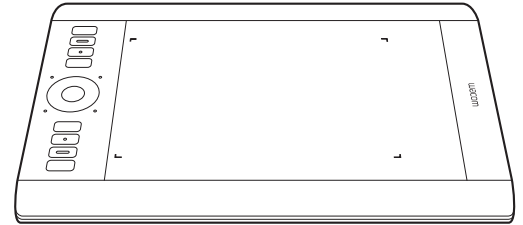

Left-handed operation:

- Open the control panel and select the [MAPPING](#) tab. Choose the EXPRESSKEYS RIGHT orientation option. The tablet driver automatically configures all aspects of the tablet (including the Wacom Tablet control panel options) for correct left-handed use.
- Next, physically rotate your tablet so the tablet ExpressKeys are positioned to the right. See also [The tablet active area](#).

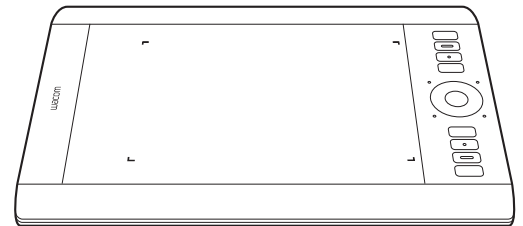

Verify that you have correctly set the orientation by moving the pen upwards on the tablet.

To work with a tall monitor:

- Choose EXPRESSKEYS TOP to work with the tablet rotated 90 degrees clockwise. The Touch Ring and ExpressKeys are oriented toward the top.
- Choose EXPRESSKEYS BOTTOM to work with the tablet rotated 90 degrees counter-clockwise. The Touch Ring and ExpressKeys are oriented toward the bottom.

Note: This procedure does not affect the default orientation. At the system log on and user switching screens, the tablet uses the default orientation you chose during the install process. To change the default orientation, you must re-install the tablet driver.

THE TABLET ACTIVE AREA

Depending on your tablet model, Intuos pro can accept pen input or both pen and touch input. The tablet active area is the area of your Intuos pro tablet that senses pen input or touch.

Touch is ignored whenever the pen tip or eraser is within the tablet proximity range. Lift the pen and your hand away from the tablet active area to enable touch.

Wherever you place the pen on the tablet, the screen pointer will jump to the corresponding point on the screen. The screen pointer indicates pen position, and follows the movement of the pen across the tablet surface.

Note: The active area is a mapped representation of your computer screen(s). By default it uses the entire screen, or all screens if you have multiple displays. You can customize the mapping relationship for pen input by setting the [Tablet to screen mapping](#).

Learn about [the touch experience with Intuos pro](#). Also see the Wacom Gesture Guide for Windows and Mac at www.wacom.com/en/support/manuals.

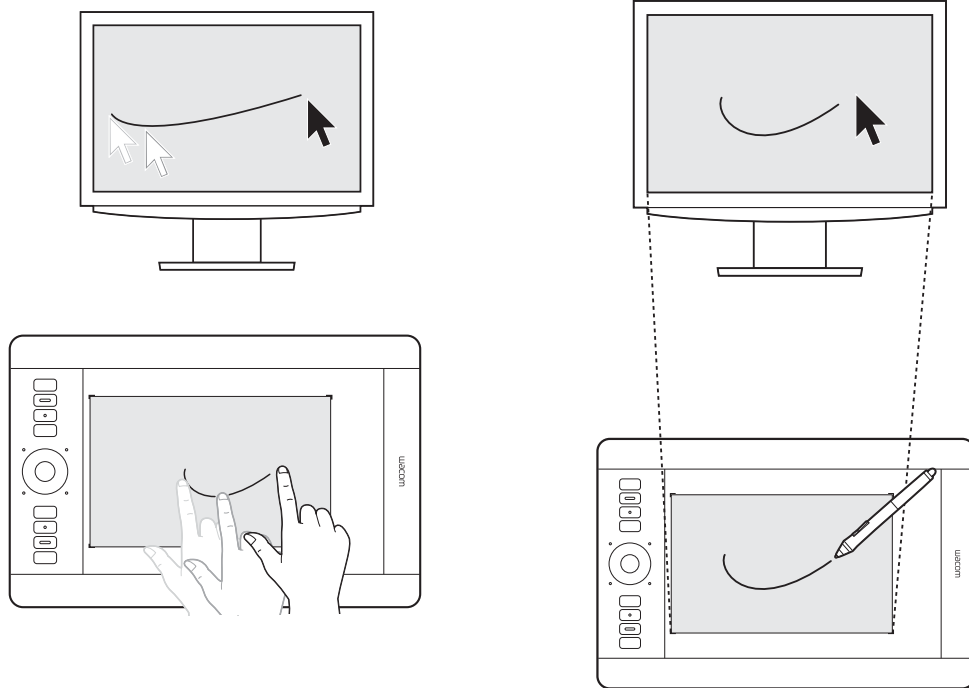

WORKING WITH MULTIPLE MONITORS

If your computer is equipped with more than one monitor, Intuos pro will map to the monitors based on how they are configured in the display properties control panel.

- If more than one monitor is in use and you are in extended monitor mode, the tablet maps to all monitors as if they were one large display.

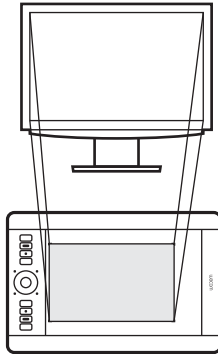

Example of tablet mapping to a single monitor.

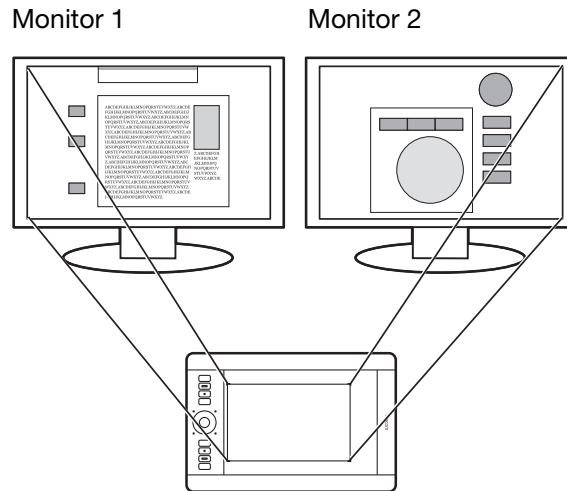

Example of tablet mapping to the entire system desktop, which is displayed on two monitors.

- If your monitors are in mirror mode (both monitors display the same content), the tablet maps to the entire space on each monitor and the screen cursor is displayed on each monitor simultaneously.

See your hardware and operating system documentation for details on configuring your computer and operating system for use with multiple monitors.

Tips:

- You can customize the tablet to map to a single monitor or to a portion of the monitor area. See [Tablet to screen mapping](#).
- When your system is configured with multiple monitors, you can assign the DISPLAY TOGGLE function to an ExpressKey. This enables you to toggle the current tablet mapping and screen cursor between the primary display and your other monitors. See [working with Display Toggle](#).

CONTROL PANEL OVERVIEW

Use the Wacom Tablet control panel to customize your Intuos pro tablet or tools. When you open the control panel, an icon for the Intuos Pro Pen or other tool is displayed in the TOOL list. A TOUCH icon and applicable tabs are displayed.

Tool Tips are available for most control panel items. Position the screen cursor over an item and let it rest there. The appropriate Tool Tip will pop up in a few moments.

Your keyboard tab and arrow keys can also be used to navigate the control panel. See [Control panel](#).



USING INTUOS PRO

This section describes the functionality of the Intuos pro. See also [The Intuos pro multi-touch experience](#)

Important: Use only a compatible Wacom pen, such as the pen that shipped with your product, or a Wacom accessory tool specified for use with Intuos pro. Other pens may not function properly.

SETTING UP YOUR WORK AREA

To minimize fatigue, comfortably organize your work area. Position your tablet, pen, and keyboard for easy access without unnecessary reaching.

Adjust your monitor so you can view it comfortably with minimum eyestrain, and placed approximately an arm's length in front of you. For best results, position the tablet so the screen cursor follows the same direction as your hand movements on the tablet.

Use a gentle grip when working with the Intuos Pro Pen or other tools.

If you are using the tablet primarily as a creative tool, consider placing the tablet below the keyboard and centered underneath your monitor.

[Using the Pen](#)

[Tablet controls](#)

USING THE PEN

The Intuos Pro Pen is cordless and battery-free. It senses the amount of pressure and tilt you apply to it.

Optional pens may also be used with the Intuos pro. See [Using the optional Airbrush and Art Pen](#).

There are four basic techniques for using the pen on the active area of the tablet: pointing, clicking, double-clicking, and dragging. If you are unfamiliar with using the pen, try the exercises on the following pages.

Note: The pen disengages touch whenever the pen tip or eraser is within the tablet proximity range (approximately 10 mm or .04 inch from the tablet surface). Lift the pen and your hand away from the tablet active area to enable touch.

If you experience unintended touch actions, manually disable touch by pressing an ExpressKey set to TOUCH ON/OFF. When done working with the pen, press the ExpressKey again to enable touch.

You can also use the Wacom Tablet control panel to disable touch. See [Tablet controls](#).

[Holding the pen](#)

[Using the side switch](#)

[Clicking](#)

[Erasing](#)

[Dragging](#)

[Working with Tilt](#)



HOLDING THE PEN

Hold the Grip Pen as you would a normal pen or pencil. Adjust your grip so that the side switch is in a convenient location where you can easily toggle it with your thumb or forefinger. Be careful not to accidentally press the switch while drawing or positioning with the pen. Tilt the pen in any way that feels most comfortable.

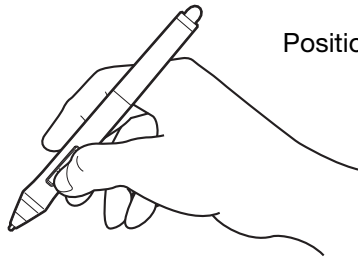

Position for drawing and navigating

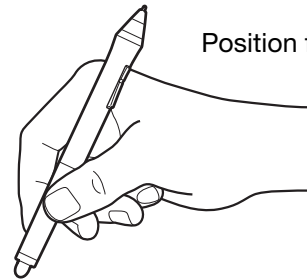

Position for erasing

Place the pen stand within easy reach of your tablet. The stand allows for vertical or horizontal placement of the pen.

Important:

- When not in use, place the pen in the pen stand or lay it flat on your desk. To maintain the sensitivity of your pen, do not store the pen in a container where it will rest on its tip or eraser.
- Leaving an Intuos Pro Pen on the tablet may interfere with screen cursor positioning when using other pointing devices, or may prevent your computer from going to sleep.

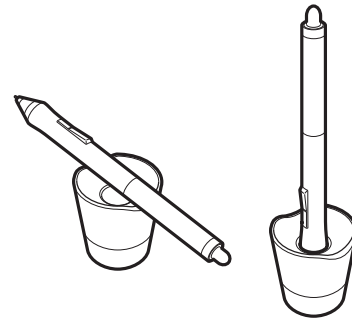



POSITIONING

To position the screen cursor, move the pen slightly above the active area without touching the screen surface. Press the pen tip on the screen to make a selection.

CLICKING

Tap the screen once with the pen tip, or touch it to the screen with enough pressure to register a click.

To double click, press the upper side switch (when set to DOUBLE CLICK), or quickly tap the screen twice in the same place with the pen tip.

ERASING

In supported applications the pen eraser works like the eraser on a pencil.

Visit the Wacom website to learn about applications that support the eraser. See [Product information](#). If the eraser is not supported in an application, you can still use it for positioning, drawing, or annotation.

DRAGGING

Select an object, then slide the pen tip across the screen to move the object.

WORKING WITH TILT

The tablet recognizes when you tilt the pen from vertical to incline positions. Tilt can be used to control line shape and thickness in supporting applications. This is like working with an airbrush where tilt can be used to make a line thin when the tool is vertical, or wide when the tool is tilted. In other applications, you can adjust tilt to define brush characteristics such as width, color, and opacity.

You can adjust the brush characteristics within your application to create different effects.

To adjust the amount of pen tilt required to produce a desired effect in your application, see [Customizing the pen](#).

WORKING WITH PRESSURE SENSITIVITY

The pen responds to the nuance and inflection of your hand movements, enabling you to create natural-looking pen and brush strokes within applications that support this feature.

To draw, ink, or write with pressure sensitivity, move the pen inside the active area while applying various amounts of pressure downward on the tip of the pen. Press hard for thick lines or dense color. Press gently for thin lines or softer color. Some applications require that you first select a pressure-sensitive tool from the application tool palette. To adjust tip feel, see [Adjusting tip feel and double-click](#).

Visit the Wacom website to learn about applications that support pressure. See [Product information](#).



USING THE SIDE SWITCH

The pen side switch has two customizable [functions](#) that can be selected by rocking the switch in either direction. You can use the switch whenever the pen tip is within 10 mm (0.4 inch) of the tablet active area. You do not have to touch the pen tip to the tablet in order to use the switch.

The default switch positions are:

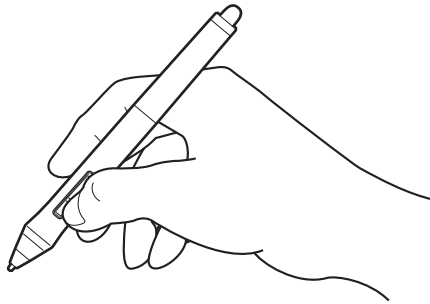

- Upper switch: double-click. This is easier than tapping twice with the pen tip.
- Lower switch: right-click. This brings up application-specific or icon-specific menus.

Tip: To position a document or image in any direction within the active window, set a switch function to PAN/SCROLL. Then press the pen button and move the pen tip across the tablet to reposition the image. Release the pen button or lift the pen tip from the tablet surface when done.

In some application windows the document will precisely follow the screen cursor as you move the pen tip. In others it will simply move in the same general direction as the screen cursor.

To assign new switch functions, see [Customizing tool buttons](#).

TABLET CONTROLS

To improve your workflow, Intuos pro features ExpressKeys and a Touch Ring. Press individual keys to perform frequently used functions or keystrokes. The tablet controls can also be used to modify touch, pen, or other tool properties as you work.

[Active area](#)

The section of your tablet that senses touch or pen input.

[ExpressKeys](#)

Press the customizable ExpressKeys to perform frequently used functions or keystrokes, or to simulate button clicks or modifier keys.

Note: Representation is Medium table with eight ExpressKeys. Small tablets are equipped with six ExpressKeys.

[Touch Ring](#)

Slide your finger around the ring to zoom, scroll, or perform other custom actions.

Press the Center Button to toggle between four customizable modes.

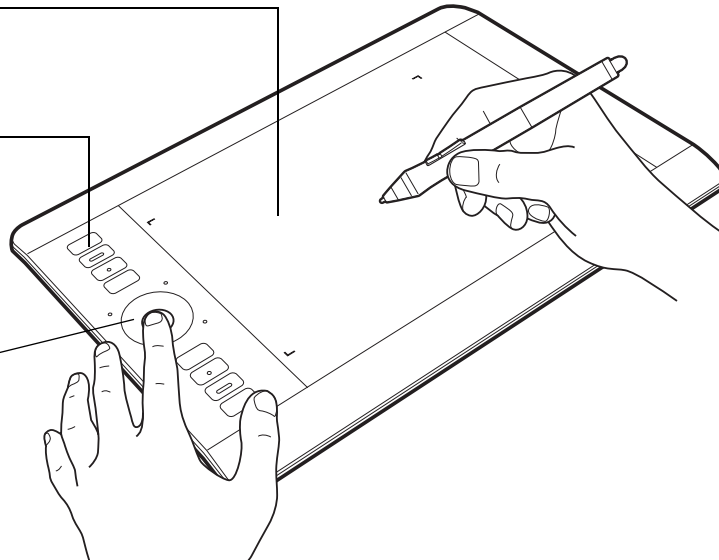

When you first begin working with your Intuos pro, the ExpressKeys are set to tablet default functions, as shown below.

See also [customizing the ExpressKeys](#) and [customizing the Touch Ring](#).

Pen & touch default settings:

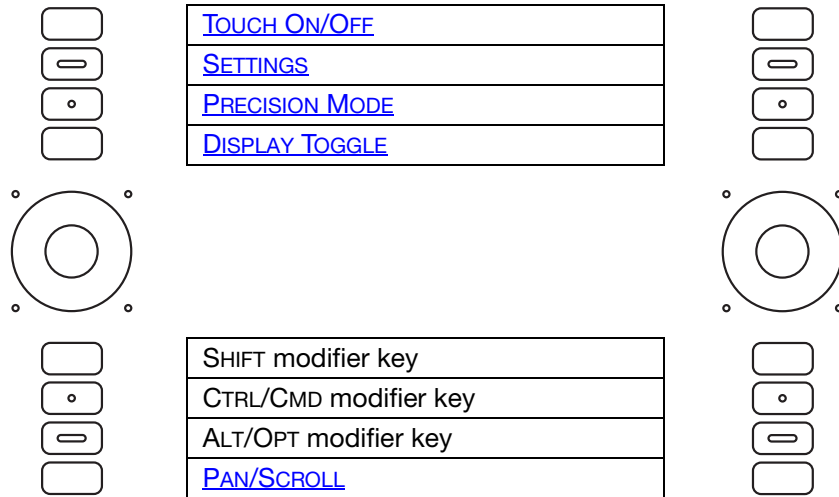

Notes:

On small tablets, the ExpressKey default settings from top to bottom are: TOUCH ON/OFF, SETTINGS, SHIFT, and CTRL/CMD, ALT/OPT, and PAN/SCROLL.

The ExpressKeys can be operated in combination with one another. For example, customize one key for the CTRL function and another for ALT. When you press both keys at the same time a CTRL+ALT function is initiated.

APPLICATION-SPECIFIC EXPRESSKEY DEFAULTS

If you are working with a commonly-used application such as Photoshop, Illustrator or Corel Painter, the Intuos driver will sense the application and automatically set the ExpressKeys to commonly used functions for that application.

Note: If you are using an application for which you have already customized your ExpressKeys, those settings will take precedence over any automatic ExpressKey default settings provided by the driver for that application. Settings will take effect automatically only if you have not entered your own ExpressKey settings for that application.

To view the current settings for the ExpressKeys, press an ExpressKey to activate the ExpressKey display on your primary monitor. The ExpressKey you touch appears highlighted in the display. See [Using the Expresskey display](#).

Note: ExpressKeys can be operated in combination with one another. For example, customize one key for the CTRL function and another for ALT. When you press both keys at the same time a CTRL+ALT function is initiated.



USING THE EXPRESSKEY DISPLAY

You can view the current setting for any individual ExpressKey at any time.

- Press an ExpressKey to activate the ExpressKey display on your primary monitor. The ExpressKey you touch appears highlighted in the display.
- If an ExpressKey has been disabled it will be shown as disabled, or there may be no display for that key.
- The display will fade out after 2 seconds on the screen.
- To disable the display, choose the EXPRESSKEYS tab in the control panel and uncheck the box.
- You can view the display by pressing an ExpressKey set to [SETTINGS](#).

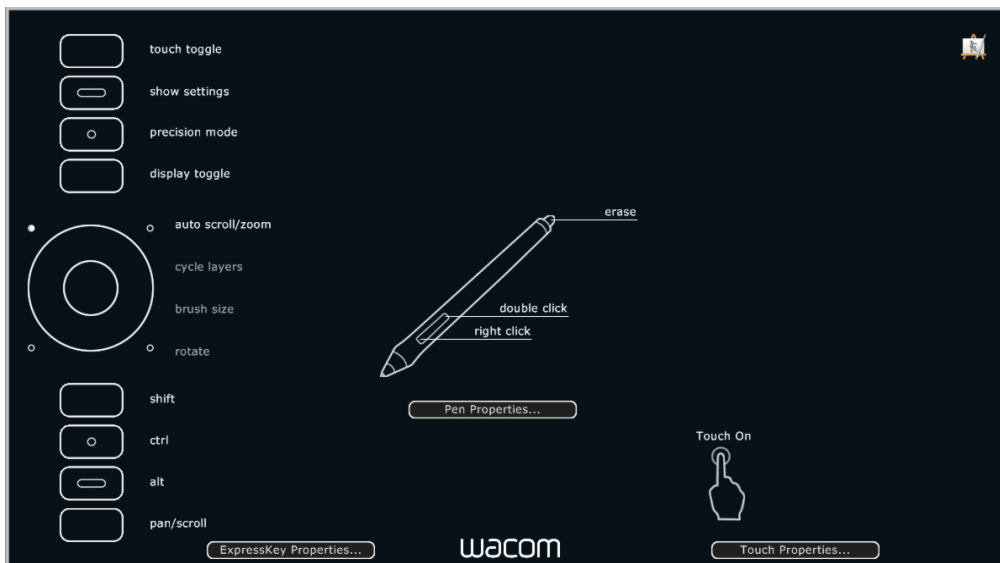

Click TOUCH PROPERTIES... to access your touch settings. Settings may vary depending on your tablet model.

You can also use the ExpressKeys to:

- Set a key to a commonly used keyboard shortcut.
- Set a key to launch a commonly used file or application.
- If you prefer not to (or cannot) use the side switches on your Grip Pen, then set a key to right-click or double-click.
- Choose from any of the other available [functions](#). See [customizing the ExpressKeys](#).

Important: Some applications can override and control the ExpressKey functions. For details, see [Using integrated applications](#).

Use the Wacom Tablet control panel to customize the ExpressKey options.

[Control panel overview](#)

[Customizing the ExpressKeys](#)



USING THE TOUCH RING

Slide your finger around the ring to zoom in or out, scroll up or down, or to issue the assigned keystroke functions.



Zooming in

Move your finger clockwise along the ring to zoom in or scroll down in most applications. Tap the upper portion of the Touch Ring for single increment changes based on the assigned function.



Zooming out

Move your finger counter-clockwise to zoom out or scroll up. Tap the lower portion of the Touch Ring for single increment changes.

Touch Ring configuration when positioned on left side of tablet. Default settings:

Tap upper or lower portion of ring for incremental changes.

Press the Center Button to toggle between four customizable modes. As you toggle between settings, a corresponding status LED illuminates. Any disabled settings are skipped in the toggle sequence.

A diagram of the current Touch Ring settings appears briefly on your display screen as you press the toggle.

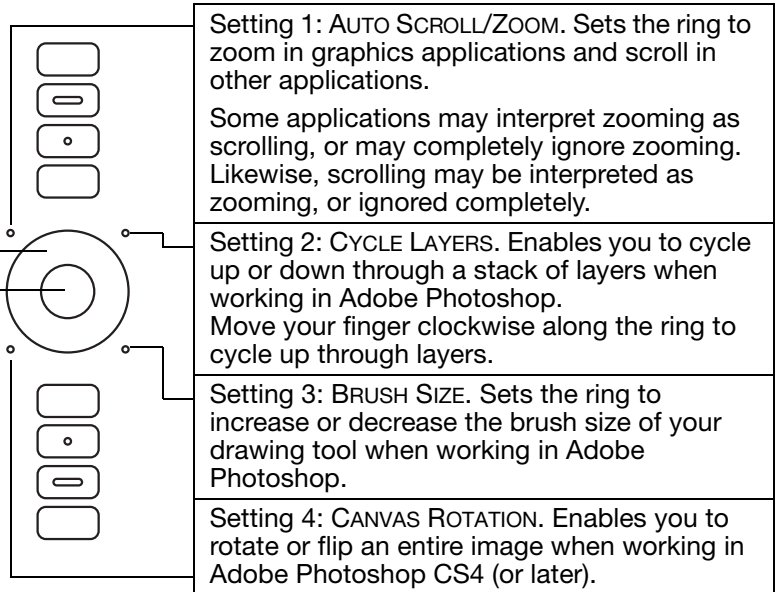
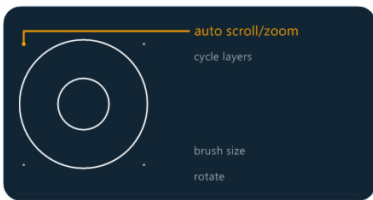

See [customizing the Touch Ring](#) to modify how the Touch Ring works.

Important: Some applications can override and control the Touch Ring functions. For details, see [Using integrated applications](#).

Use the Wacom Tablet control panel to customize the Touch Ring options.

[Control panel overview](#)

[Customizing the Touch Ring](#)

CONTROL PANEL

Use the Wacom Tablet control panel to customize your Intuos pro tablet or tools. When you open the control panel, an icon for the Grip Pen or other tablet tool and a TOUCH icon are displayed in the TOOL list.

To customize, make changes to the tab controls. Experiment with different settings to find what works best for you. Any changes you make will take effect immediately. Click DEFAULT to return to the factory settings.

Icons represent your TABLET, TOOL, and APPLICATION settings.

Choose FUNCTIONS to customize the ExpressKey, Touch Ring, and [Radial Menu](#) settings. [Display Toggle](#)

options are available on multiple monitor systems.

For touch-sensitive tablets, choose TOUCH to customize your touch settings. See [Setting the touch options](#).

Choose GRIP PEN to customize your pen settings. The icon is available after you have used a pen on the tablet. Different tools may be named differently.

Tabs display customizable settings for the selected TOOL.

Displays information dialog, and option to **DIAGNOSE...** your product.

Displays [Advanced](#)

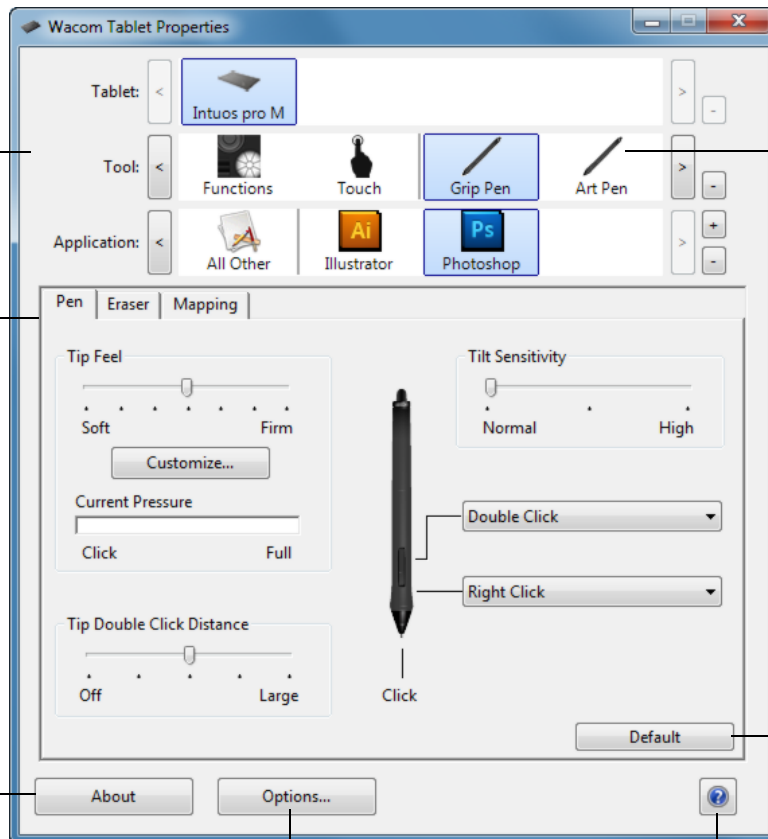

Returns the selected tab to its default settings.

Downloads or displays this manual.

To open the Wacom Tablet control panel:

- **Windows 8.** From the Windows 8 Start screen, right-click in the screen's bottom left corner and choose CONTROL PANEL from the pop-up menu. If you are using Windows 8 Classic Desktop, press the Windows key on your keyboard, or select the Windows icon in the Charms bar, to access the Start screen.
- **Windows 7 and Vista.** Click on the Windows START button and choose ALL PROGRAMS, then select WACOM TABLET and choose the WACOM TABLET PROPERTIES option.
- **Mac.** Open SYSTEM PREFERENCES from the Apple menu, or from the APPLICATIONS folder. Then click on the WACOM TABLET icon.

Tool Tips are available for most control panel items. Position the screen cursor over an item and let it rest there. The appropriate Tool Tip will pop up in a few moments.

Your keyboard tab and arrow keys can also be used to navigate the control panel.

See [Customizing Intuos pro](#).

Control panel lists and tabs: The control panel TABLET, TOOL, and APPLICATION lists allow you to select the tablet, tool, or application for which you want to change settings.

The TABLET list displays an icon for any supported tablet or pen display that has been installed on your system and is currently connected. All settings shown below the list apply to the selected tablet or pen display.

- The control panel will not launch unless a supported tablet or pen display is connected to the computer.
- Settings can only be viewed or changed for an attached tablet or pen display.
- A tablet or pen display cannot be deleted from the control panel list unless it is attached to the computer.

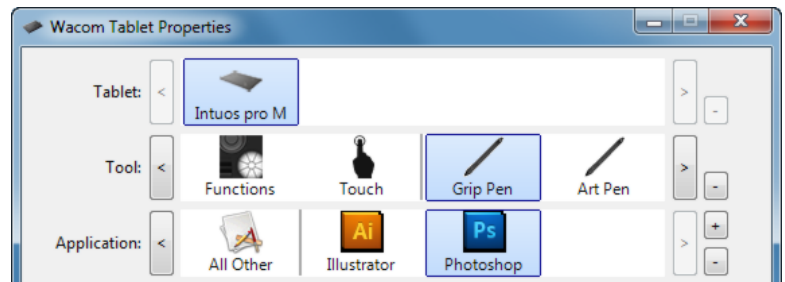

Current selections are highlighted.

See also [Installing multiple tablets](#) and [Changing the tablet mode](#).

The TOOL list displays icons for the tablet FUNCTIONS and for the different tools that have been used on the tablet. To customize settings for a tool, click on its icon within the TOOL list. The appropriate tabs will be displayed.

Note: The pen will be automatically added to the TOOL list when first used on the tablet, and functions using the default settings.

See also [Working with multiple tools](#).

Use the APPLICATION list to define TOOL settings that apply only to a specific application. See [Application-specific settings](#).

Note: The APPLICATION list is optional. It is not necessary to select or add applications in order to customize your Intuos pro tool(s).



THE INTUOS PRO MULTI-TOUCH EXPERIENCE

Intuos pro is designed to enhance the way you work. Touch enables you to interact with a computer using only your fingertips on the Intuos pro tablet.

You can use touch on Intuos pro as you would on any other Mac or Windows device, such as phones, trackpads, and notebooks. First learn the basic actions to navigate and perform typical mouse operations. Then learn how to scroll, zoom, and rotate.

Touch is activated whenever you touch the tablet. See [The tablet active area](#).

- When using touch, you can generally position your fingers as far apart as is comfortable. However, placing your fingers too closely together may be interpreted by the tablet as input from a single finger, or the tablet may confuse which finger initiated or performed an action or gesture. Your fingers must remain within the active area.
- Experiment with touch to see what works best for you. Take care to prevent accidental touches on the tablet when making gestures. For example, if your small finger or the palm of your hand touches the active area of the tablet when zooming or scrolling, then you may trigger an unanticipated right-click.

[Navigating with touch](#)

[Setting the touch options](#)



NAVIGATING WITH TOUCH

The touch feature of your Intuos pro touch tablet enables you to control a computer using only your fingertips on the tablet surface. See [The tablet active area](#).

Touch options can be individually enabled or disabled within the Wacom Tablet control panel. Touch is on when selected in the TOUCH OPTIONS tab (see [Setting the touch options](#)).

- Use basic actions to navigate and perform typical mouse operations.
- Use gestures to scroll, zoom, rotate, and perform other functions. Some gestures may provide a visual cue on your display screen to indicate when the gesture has been recognized by Intuos pro.

Some functions, such as a right-click, can be performed using different actions or gestures.

Position the screen cursor over a touch option to see a static image of that function.

If you do not choose a specific option to view, the control panel will display each option sequentially, from top to bottom.

This option can also be changed by assigning it to an ExpressKey.

See also [Navigating with touch](#) and [Choosing custom touch functions](#).

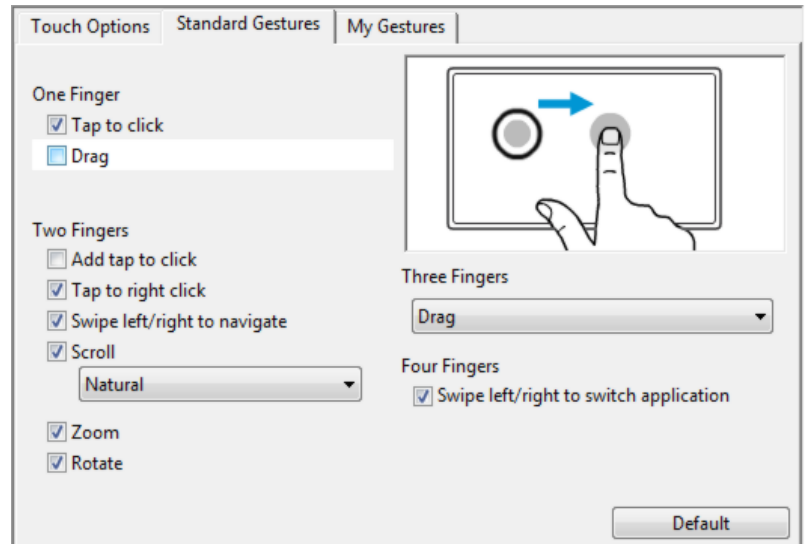

Windows screen capture shown. Available options may vary, depending on your operating system and version.

You can also:

- [Customize your touch experience](#) and also [customize the ExpressKeys](#) to perform some touch functions.
- Select the TOUCH icon in the TOOL list. Then select an appropriate tab to customize, and change settings using the available options. See also [Navigating with touch](#).

[Choosing custom touch functions](#)

[Choosing custom touch functions](#)

[Navigating with touch](#)

SETTING THE TOUCH OPTIONS

Select the TOUCH OPTIONS tab. The touch options determine how fast you must move or tap your fingers in order for an action or gesture to be recognized.

Adjusts the screen pointer for speed of tracking and navigating. Choose a SLOW speed to move the screen cursor at a slower rate with more finger motion. Choose a FAST speed to move the screen cursor quickly with less motion.

Check the box to enable touch input.

DOUBLE-TAP TIME adjusts how fast you must tap to register a double-click. To test your setting, position the screen cursor over the TEST area and tap twice.

Sets the scrolling speed of the SCROLL touch gesture.

Sets the acceleration level of the screen pointer. Choose a LOW setting for a slower response to your finger motion on the tablet. Choose a HIGH setting for a quicker response.

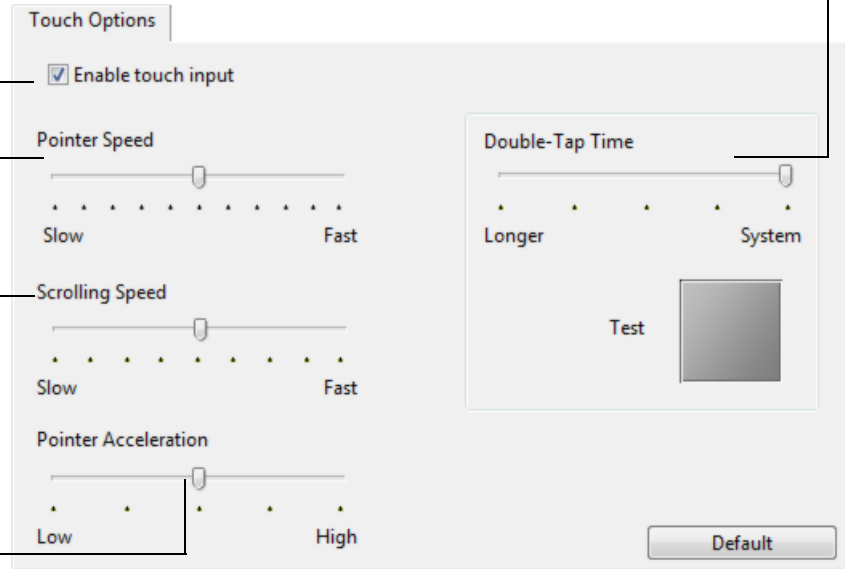

Note: Touch speed and acceleration settings are independent of system settings. Changes you make to these settings in the Wacom Tablet control panel do not affect similar system settings. However, changes made to similar system settings may affect your Intuos Pro tablet settings.

CHOOSING CUSTOM TOUCH FUNCTIONS

To create custom touch gestures, select the MY GESTURES tab.

[Touch](#) gestures are available when selected, and are modified based on your selection from the drop-down menus.

Position the screen cursor over a touch option to see a static image of that function.

If you do not choose a specific option to view, then the control panel will display each option sequentially, from top to bottom.

See also [Navigating with touch](#) and [Choosing custom touch functions](#).

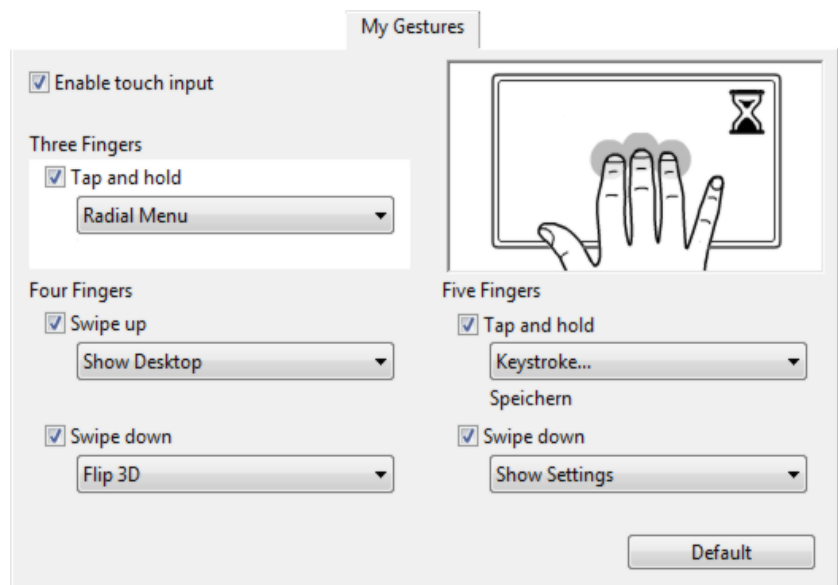

Windows screen capture shown. Available options may vary, depending on your operating system and version.



CUSTOMIZING INTUOS PRO

Use the Wacom Tablet control panel to customize Intuos pro for the way you like to work.

Advanced users can learn how to further optimize Intuos pro by creating [Application-specific settings](#).

[Control panel overview](#)

[Customizing the pen](#)

[Setting the touch options](#)

[Tablet to screen mapping](#)

[Button functions](#)

[Working with Display Toggle](#)

[Application-specific settings](#)

[Working with multiple tools](#)

[Changing the tablet mode](#)

[Advanced options](#)

To open the Wacom Tablet control panel:

- **Windows 8.** From the Windows 8 Start screen, right-click in the screen's bottom left corner and choose CONTROL PANEL from the pop-up menu. If you are using Windows 8 Classic Desktop, press the Windows key on your keyboard, or select the Windows icon in the Charms bar, to access the Start screen.
- **Windows 7 and Vista.** Click on the Windows START button and choose ALL PROGRAMS, then select WACOM TABLET and choose the WACOM TABLET PROPERTIES option.
- **Mac.** Open SYSTEM PREFERENCES from the Apple menu, or from the APPLICATIONS folder. Then click on the WACOM TABLET icon.

You can begin customizing Intuos pro after opening the control panel. The control panel displays only those tabs and options that apply to your current tablet model and configuration. See [Control panel overview](#).

Note: User-specific preferences are supported. After logging on, each user can customize their personal settings in the Wacom Tablet control panel. Switching to another user will automatically load the settings for that user.





CUSTOMIZING THE PEN

You can easily customize the pen. Use the pen to open the Wacom Tablet control panel. The pen will be selected in the TOOL list and the appropriate tabs will be displayed. If not automatically selected, choose the pen from the TOOL list. Select a tab and choose from the available options.

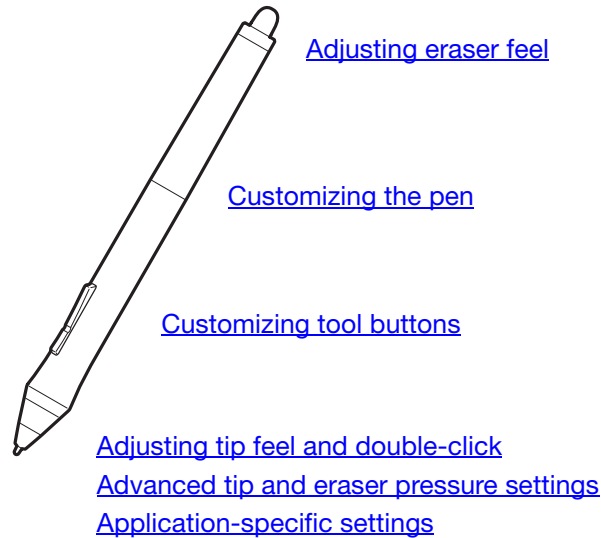

Wacom offers a number of optional pens, such as the Art Pen and Airbrush, that are compatible for use with Intuos pro.

- The Art Pen features a pressure-sensitive tip and eraser, as well as sensitivity to tilt and rotation. Rotating the barrel in supporting applications creates a unique effect.
- The Airbrush is a true digital airbrush. It features a pressure-sensitive tip and eraser, tilt sensitivity, and a fingerwheel to control the application of digital paint.

These tools are fully supported in the Wacom driver software. They will appear in the TOOL list of the Wacom Tablet control panel after you touch the tablet surface with the tip of the tool. The control panel will automatically update to show the new tool and the options available for customization.

In supporting applications you can adjust the functionality of the Art Pen rotation or the Airbrush fingerwheel within the application. See the documentation that came with your application for details.

To learn more about these and other optional tools that can be used with Intuos pro, visit <http://wacom.com> and choose the Wacom web site for your region. On the web site you can also learn about applications that currently support the advanced features of these tools.



ADJUSTING TIP FEEL AND DOUBLE-CLICK

To adjust the tip sensitivity of your pen, select the PEN tab.

The TIP FEEL slider customizes the amount of pressure needed to click, draw, or ink.

To create broad brush strokes or to click with a light touch, use a SOFT tip setting. For maximum control while drawing thin lines, use a FIRM tip setting.

Click to [further customize](#) the tip sensitivity.

With your screen cursor positioned over an empty area of the control panel, press down on the tablet with the pen tip. Use the pressure bar to determine how hard you must press on the pen to reach maximum pressure.

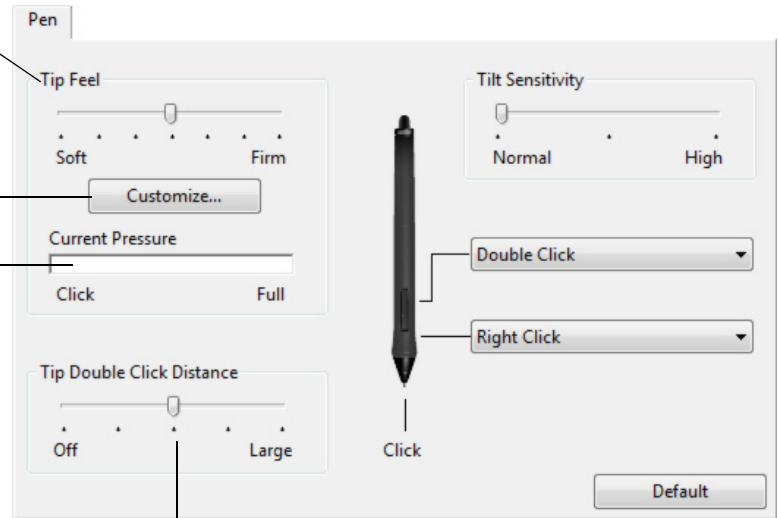

Adjusts the size of the double-click area. Drag slider to OFF if you do not want [double-click assist](#).

Tips:

- Use a soft TIP FEEL for a wider range of pressure values in most pressure-sensitive applications.
- In some applications a soft pressure setting can make the pen overreact so that slight pressure on the pen will be magnified on the screen. If you experience this, try a firmer TIP FEEL setting.
- To make double-clicking easier, expand the tap area that accepts a double-click (the double-click distance).
- A large double-click distance may cause a delay at the beginning of brush strokes in some drawing applications. This may also cause a delay at the beginning of a drag action or inking stroke. If you notice such effects, try setting a smaller double-click distance and using the side switch to double-click. You can also [set an ExpressKey to double-click](#).

ADJUSTING ERASER FEEL

To adjust the eraser sensitivity of your pen, select the ERASER tab.

Select the [function](#) to perform when using the eraser.

Customizes the amount of pressure needed to erase.

Click to [further customize](#) the eraser sensitivity.

With your screen cursor positioned over an empty area of the control panel, press down on the tablet with the pen eraser. Use the pressure bar to determine how hard you must press on the eraser to reach maximum pressure.

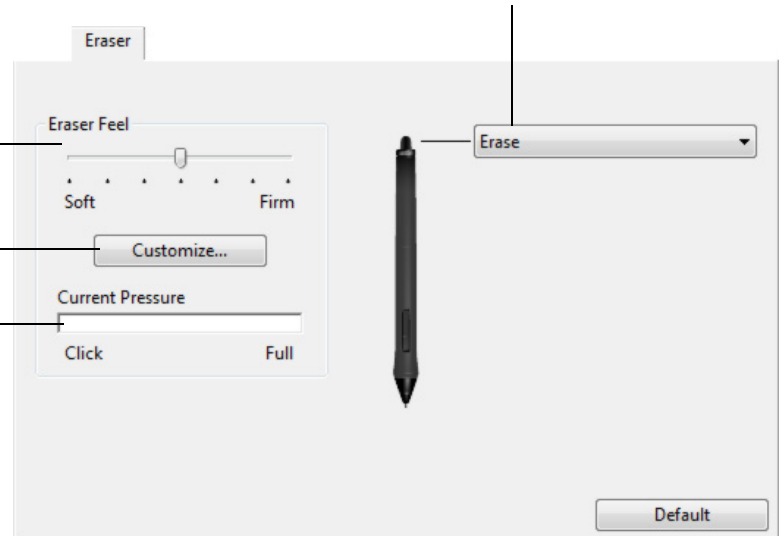

ADVANCED TIP AND ERASER PRESSURE SETTINGS



To further customize tip or eraser pressure settings, select the PEN or ERASER tab and click on the CUSTOMIZE... button. Options within the PEN FEEL DETAILS dialog box enable you to independently change the tip or eraser pressure sensitivity and click threshold settings.

Graphically displays the selected pressure sensitivity curve and click threshold settings.

Move the pressure controls to change the sensitivity curve.

- CLICK THRESHOLD determines the amount of force required to register pressure or generate a pen click.
- Use the SENSITIVITY control to change the slope of the pressure response curve.
- MAX PRESSURE determines how hard you must press the pen tip to reach maximum pressure.

A curve that increases quickly makes the pen feel more sensitive.

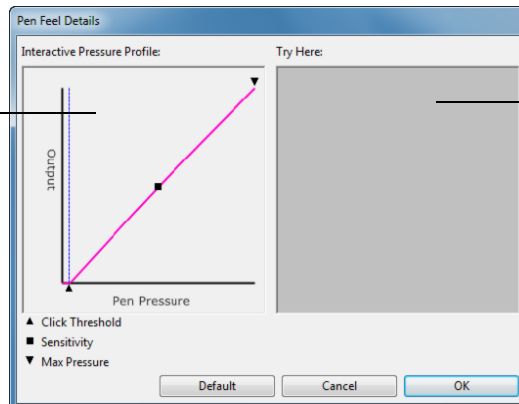

Using your pen tip or eraser, make several strokes within the box to test the results of your changes.

Important: In the PEN and ERASER tabs, these settings are adjusted simultaneously with the TIP FEEL or ERASER FEEL slider, which override the advanced pressure settings.

CUSTOMIZING TOOL BUTTONS

Select the PEN tab to change the functions assigned to the side switches and tip of your pen.

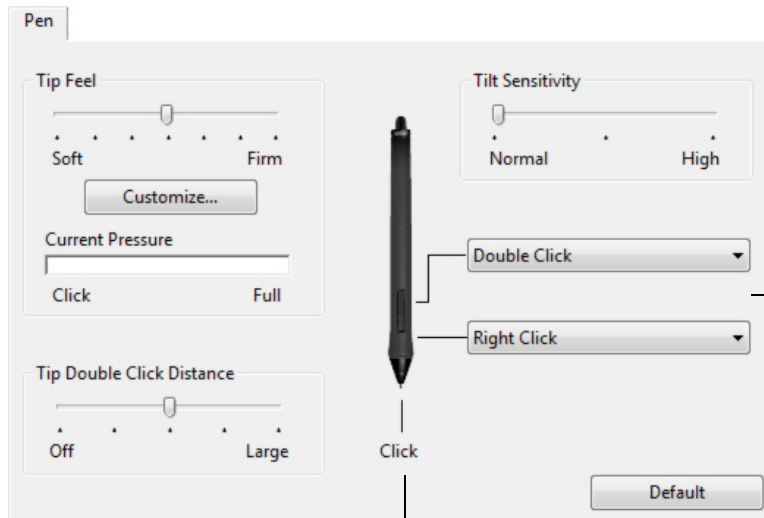

Select the [function](#) to perform when pressing the upper or lower side switch.

The selected function occurs when you bring the pen tip within 10 mm (0.4 inch) of the tablet surface without touching the tablet and then press the upper or lower side switch.

Tip: To make double-clicking easier, set the side switch to DOUBLE CLICK.

Drag the TILT SENSITIVITY slider to change tilt sensitivity. Test the new setting in an application that supports tilt.

The tilt setting applies to both the tip and eraser of your tool.

Tilt is direction sensitive and can be used in some applications to control brush orientation or other characteristics.

Double-click here to change the pen tip function.

- At least one tool button should be set to the CLICK function.
- The tip must be set to CLICK in order to draw in most graphics applications.

Note: You can change how the side switch operates for right clicks or other click functions. See [Advanced options](#).

CUSTOMIZING THE EXPRESSKEYS

To customize the ExpressKeys, select the EXPRESSKEYS tab. Each key can be customized to perform a Display Toggle, modifier, keystroke, or other function.

When you open the EXPRESSKEYS tab, the current functions are shown in the corresponding pull-down menus.

Choose a [function](#) to perform when the key is pressed.

ExpressKey functions can be defined for use with [specific applications](#).

See [using the ExpressKeys](#) for more information.

Note: Small-sized tablets are equipped with six ExpressKeys.

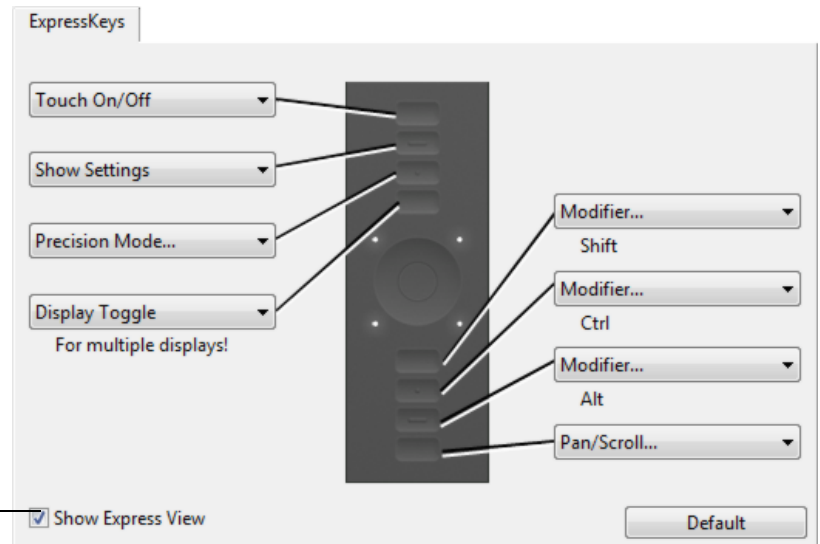

Enables or disables the Express View display.

When enabled, you can rest your finger on an ExpressKey to show the ExpressKey settings.

See [Using the Expresskey display](#).

Tab shown for right-handed use.

Important: Some applications can override and control the ExpressKey functions. For details, see [Using integrated applications](#).

CUSTOMIZING THE TOUCH RING

To customize the Touch Ring, select the TOUCH RING tab. Touch Ring functions can be modified to perform various zooming, scrolling, or custom keystroke actions.

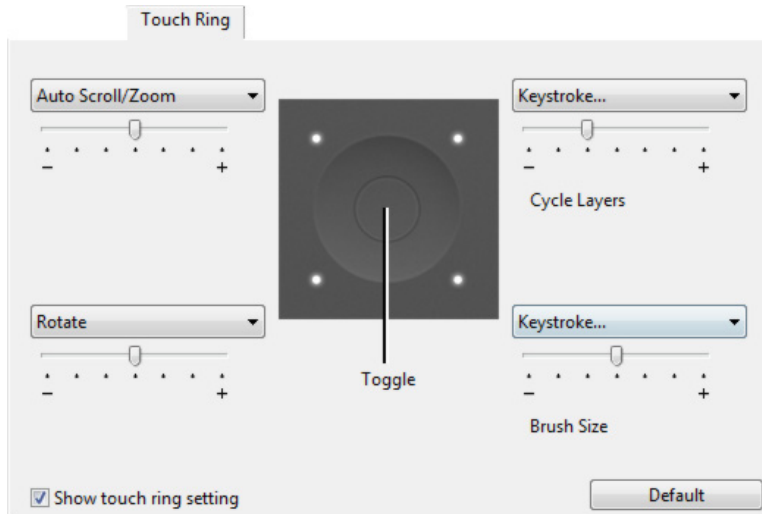

Choose a function to perform when using the Touch Ring. The ring can be toggled between four customizable modes.

Adjust speed to control the rate at which zooming and scrolling occurs, or the speed at which keystroke events are sent to an application.

Touch Ring functions can be defined for use with [specific applications](#).

See [using the Touch Ring](#) for more information.

The checkbox enables or disables display of the Touch Ring settings diagram.

Tips:

- To customize the ring for other actions, select the KEYSTROKE... option and define a custom [keystroke](#) function. To learn which keystroke shortcuts are supported by a particular application, see the documentation that came with the application.
- Choose SKIP to set the Touch Ring toggle button to skip a function mode in the toggle sequence.
- To zoom images at the current position of the screen cursor in Adobe Photoshop CS3 (or later), open the Adobe Photoshop general preferences pane. Check the ZOOM WITH SCROLL WHEEL option and click OK.
- To set the brightness of the Touch Ring status LEDs and active area markers, click the OPTIONS... button at the bottom of the Wacom Tablet control panel. In the OPTIONS dialog box change the BRIGHTNESS ADJUSTMENT setting as needed.

Important: Some applications can override and control the Touch Ring functions. For details, see [Using integrated applications](#).

[Customizing the ExpressKeys](#)

[Customizing the Touch Ring](#)

[Working with Display Toggle](#)

[Application-specific settings](#)

TABLET TO SCREEN MAPPING

Select the **MAPPING** tab to define the relationship between tool movement on the tablet surface and cursor movement on the monitor screen.

By default the entire active area of the tablet maps to the entire monitor. If more than one monitor is in use the tablet will map to all monitors. See [Working with multiple monitors](#).

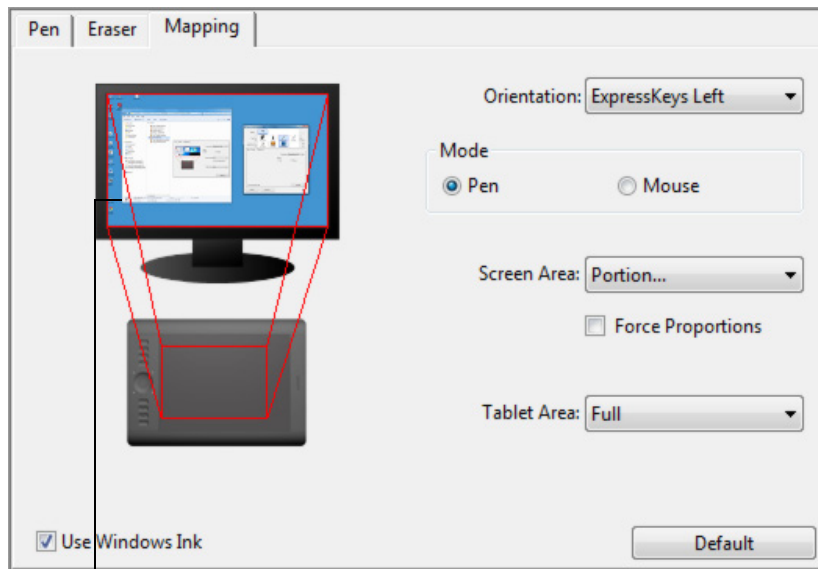

Image dynamically updates to illustrate the selected mapping relationship.

When **FORCE PROPORTIONS** is unchecked, the correct scale or proportions are not maintained. The selected tablet area is mapped to the selected display area. Drawing a circle on the tablet may create an ellipse on the display screen. This is the default setting for all tools.

When **FORCE PROPORTIONS** is checked, the correct vertical and horizontal proportions are maintained. Drawing a circle on the tablet results in a circle on the display screen. Depending on your settings, some portions of the tablet active area may no longer be usable when this option is selected.

Note: Although Intuos Pro is optimized for use with 16 : 10 aspect ratio displays, the default settings automatically adjust for use with other aspect ratio displays.

The **ORIENTATION** setting is tablet specific, and applies to all tools and applications. See [Installing the driver](#).

MODE options control how the screen cursor moves.

- **PEN MODE** sets the cursor movement to correspond with the position of your pen on the tablet. Wherever you place your pen on the tablet, the cursor will jump to a corresponding point on the screen. This is known as absolute positioning and is the default setting for the pen.
- **MOUSE MODE** enables you to move the screen cursor with a “pick up and slide” motion similar to using a standard mouse.

Select a [Portion of screen area](#) for tablet to screen mapping.

Select a [Portion of tablet area](#) for tablet to screen mapping.

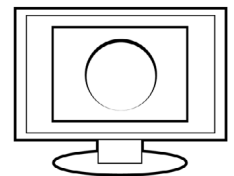
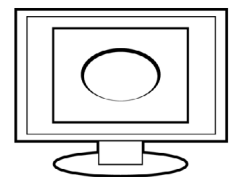

Use ORIENTATION to select right or left orientation for the ExpressKeys.

MODE options control how the screen cursor moves.

- PEN MODE sets the cursor movement to correspond with the position of your pen on the tablet. Wherever you place your pen on the tablet, the cursor will jump to a corresponding point on the screen. This is known as absolute positing and is the default setting for the pen.
- MOUSE MODE enables you to move the screen cursor with a “pick up and slide” motion similar to using a standard mouse. (Also see [Using the optional mouse.](#))

Use ORIENTATION to select right or left orientation for the ExpressKeys.

Use WINDOWS INK to activate the Press and hold to right-click, Flicks, and Ripples features in Windows Ink.

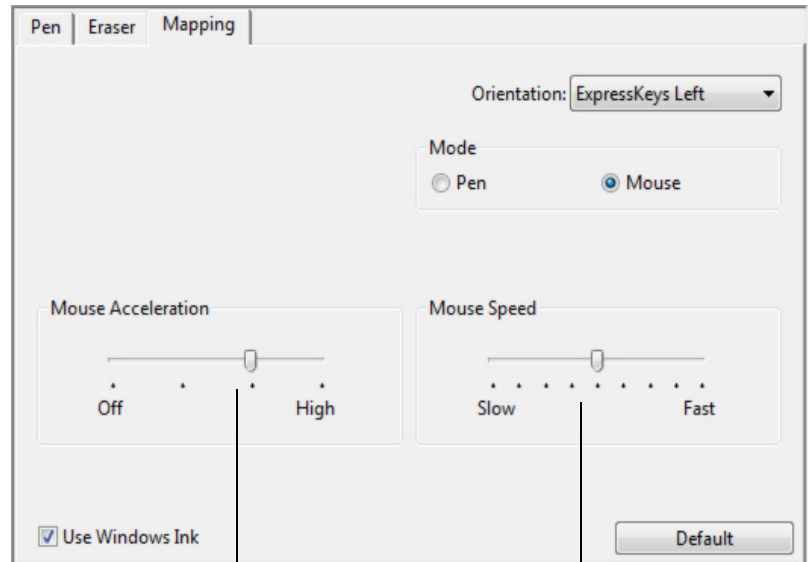

Select the screen cursor acceleration.

Select a slower or faster screen cursor tracking speed.

Notes:

You can switch between pen mode and mouse mode by using the [Radial Menu](#).

If you frequently switch between pen mode and mouse mode, you can assign the [MODE TOGGLE...](#) function to one of your tool buttons.

PORTION OF SCREEN AREA

To define which portion of the display screen your tablet will map to, in the MAPPING tab choose a SCREEN AREA option.

FULL	Maps the entire monitor(s) area. This is the default setting. See also Working with multiple monitors .
MONITOR	Maps the entire area of a single monitor that you choose. If more than one monitor is connected to your system, an option will be available for each detected monitor.
PORTION...	In the dialog box that appears, choose a method for defining a portion of the display:

- Drag corners of the foreground graphic to select the screen area.
- Select the CLICK TO DEFINE SCREEN AREA button and move the screen cursor to select the screen area. Be sure to follow any MESSAGE prompts.
- Enter coordinate values.

After defining a portion of the screen, you may need to use a different input device to access other portions of the screen area.

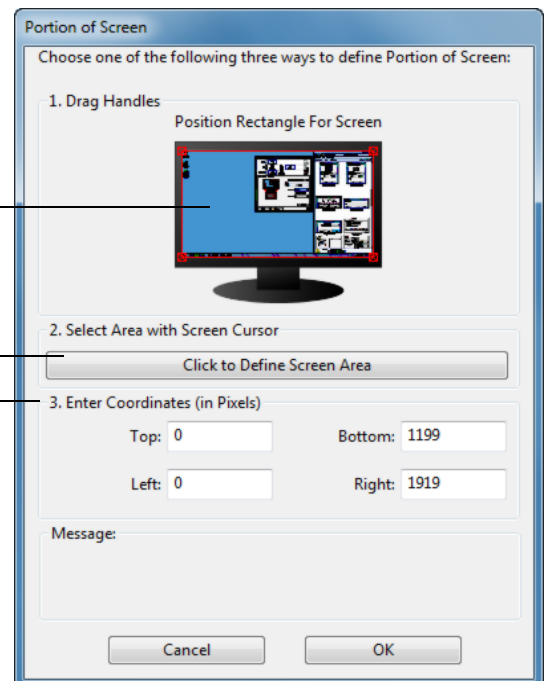

PORTION OF TABLET AREA

To define the tablet area that will be mapped to the screen area, in the MAPPING tab choose a TABLET AREA option.

FULL

The entire active area of the tablet is mapped. This is the default setting.

PORTION...

In the dialog box that appears, choose a method for defining a portion of the tablet:

- Drag the corners of the rectangle to select the tablet area that will be mapped to your selected screen area.
- Select the **CLICK TO DEFINE TABLET AREA** button and use your tool on the tablet to select the tablet area. Be sure to follow any MESSAGE prompts.
- Enter coordinate values.

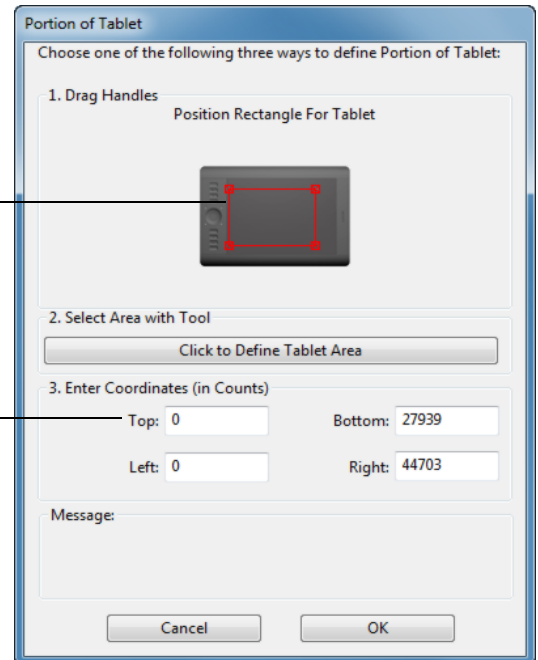



BUTTON FUNCTIONS

Customize Intuos pro for the way you like to work. Simply use the Wacom Tablet control panel to change the button function that is assigned to a tool button, ExpressKey, Touch Ring, or Radial Menu setting. Button function options may vary, depending on your tablet model. Not all options are available for all controls or tablet models.

FUNCTION NAME	DESCRIPTION
CLICKS	
• CLICK	Simulates a primary mouse button click. Be sure at least one button performs this function so you can always navigate and click.
• RIGHT CLICK	Simulates a right mouse button click, which displays a context menu.
• MIDDLE CLICK	Simulates a middle mouse button click.
• DOUBLE CLICK	Simulates a double-click. For easier double-clicking, use this function instead of tapping twice with the pen tip.
• CLICK LOCK	Simulates holding down the primary mouse button. Press the tool button once to initiate click lock. Press the button again to release click lock. Click lock is useful for dragging objects or selecting blocks of text.
• 4TH CLICK	Simulates a 4th mouse button click.
• 5TH CLICK	Simulates a 5th mouse button click.



FUNCTION NAME

DESCRIPTION

KEYSTROKE...

Enables you to simulate keystrokes. Select this option to display the DEFINE KEYSTROKE dialog box.

Enter a keystroke or keystroke combination in the KEYS entry box. Keystroke combinations can include letters, numbers, function keys (such as F3) and modifier keys (such as SHIFT, ALT, or CTRL for Windows, or SHIFT, OPTION, COMMAND, and CONTROL for Mac). You can also choose special keystrokes or keystroke combinations from the ADD SPECIAL drop-down menu.

After defining a keystroke sequence, click OK.

Important: Because the ENTER (Windows) and RETURN (Mac) keys can be selected as a defined keystroke, they cannot be used to select OK. You must use your Intuos pro tool to click on the OK button.

Enter a name for the keystroke definition. The name will be displayed with the respective control or in the Radial Menu, as applicable.

You can create different keystroke functions for different applications. See [Application-specific settings](#).

Deletes only the last entry in the keystroke entry box.

Clears the keystroke entry box.

When defining keystrokes for the Touch Ring or mouse fingerwheel, the dialog box provides two KEYS entry boxes.

Assign keystroke functions as described above for clockwise and counter-clockwise movement on the ring, or for front and back movement of the mouse fingerwheel.

Enter a NAME for the defined keystrokes pair and click OK.

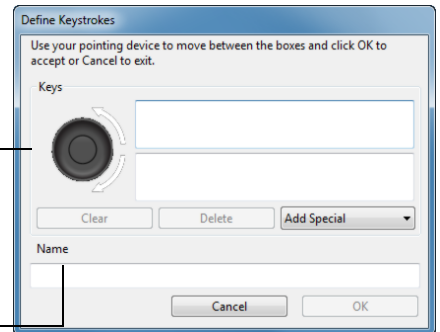
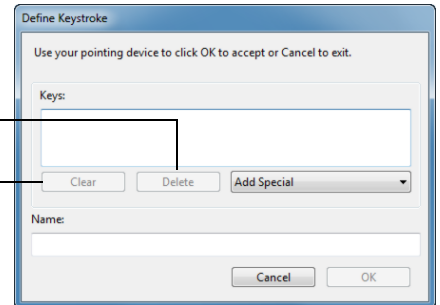

To learn which keystroke shortcuts are supported by a particular application, see the documentation that came with the application.

FUNCTION NAME **DESCRIPTION**

MODIFIER...

Enables you to simulate modifier key(s) (such as SHIFT, ALT, or CTRL for Windows, or SHIFT, OPTION, COMMAND, and CONTROL for Mac). Many applications use modifier keys to constrain the size or placement of objects.

Choose one or more modifier key options.

Choose a CLICKS option to simulate pressing a button of the selected type on a mouse.

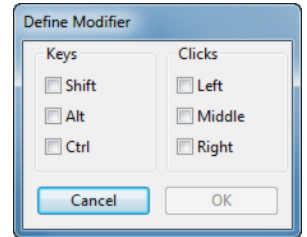

RADIAL MENU

Displays the [Radial Menu](#) on your screen. Each level of the hierarchical menu consists of eight menu slices which may contain various features and options to choose from.

BACK

Simulates the BACK command in browser applications.

FORWARD

Simulates the FORWARD command in browser applications.

PAN/SCROLL

Enables you to position a document or image in any direction within the active pane. Do this by pressing a pen button set for PAN/SCROLL and then dragging with the pen tip across the tablet active area.

When you select PAN/SCROLL, you are prompted to set a scrolling speed for use in applications that do not support grabber hand (pixel-level) panning.

A slower setting reduces the scroll rate and is useful for close-up and detail work where you need precise control of the image.

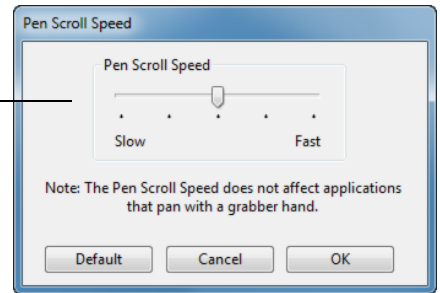

As you move the pen tip, the document or image is repositioned to follow the direction of pen movement on the tablet.

Release the button or lift the pen tip from the tablet surface when you are done.

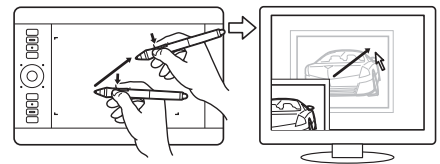

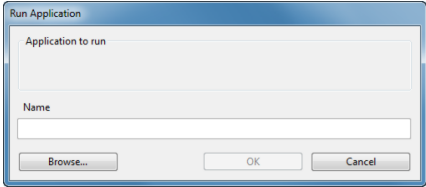

FUNCTION NAME	DESCRIPTION
AUTO SCROLL/ZOOM	Sets the Touch Ring to zoom in most graphics applications and scroll in most other applications.
SCROLL	Sets the Touch Ring for scrolling only action.
ZOOM	Sets the Touch Ring for zooming only action.
SHOW DESKTOP	Minimizes all open windows to display a clean desktop.
SWITCH APPLICATION	Brings up the application switching dialog box with focus on the next open application. On Windows 7 and Vista systems running Aero, Flip 3D will be activated with focus on the next open application.
OPEN/RUN...	<p>Opens a dialog box where you can select a specific application, file, or script to launch.</p> <p>Click BROWSE... to locate an application, file, or script to launch. The selection you make appears in the NAME box. Click OK to accept the selection.</p>  <p>The dialog box will close and the OPEN/RUN... option you have selected will be assigned as your tool button option. Simply press the tool button to launch the assigned option.</p> <p>If your selection is for the Radial Menu, it will be displayed there.</p>
TOUCH ON/OFF	<p>TOUCH ON/OFF is useful when you are working with the pen and you want to exclusively use pen mode.</p> <p>Temporarily disable touch by pressing an ExpressKey to which you have assigned the TOUCH ON/OFF function. Press the ExpressKey again to enable touch. See also customizing the ExpressKeys.</p>
INK TOGGLE	(Mac only.) Toggles the “ink in any application” function of Ink on and off. Ink automatically recognizes and converts your handwriting into text and inserts it into a document. Handwriting recognition must be turned on for this function to work. See your Mac help for information on working with Ink.
EXPOSÉ	(Mac only.) Tiles all open windows. To access this option, first choose KEYSTROKE... and then click on the ADD SPECIAL menu within the dialog box.
PRESSURE HOLD	Locks the pressure at the current pressure level until the button is released. For example, you can paint with pressure sensitivity until you reach the brush size that you like. You can then press the button and continue painting with the same size brush until the button is released.



FUNCTION NAME **DESCRIPTION**

PRECISION MODE

Changes the mapping around the current pen tip position so that you must move the pen farther for the screen cursor to cover a specific distance on the display screen. This feature can be very useful for the precise control of pen or brush strokes.

You can adjust the precision setting when assigning this function to a tool button.

To activate:

- For **extensive use**, toggle on PRECISION MODE by pressing a tool button to which the function has been assigned. Return to normal mapping by again pressing the tool button.
- For **quick edits**, press and hold a tool button to which the function has been assigned. Normal mapping returns when you release the button.

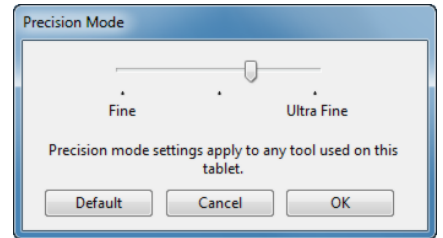

When using a tool in mouse mode, screen cursor movement is adjusted to act as if acceleration were off and speed set to slow.

DISPLAY TOGGLE

For multiple monitor systems. Enables you to toggle the current tablet mapping and screen cursor between different displays when you press an ExpressKey that has been assigned this function. See [working with Display Toggle](#).

MODE TOGGLE...

Toggles between [pen mode](#) and [mouse mode](#). When first setting a tool button to MODE TOGGLE..., the MOUSE MODE dialog box is displayed where you can adjust the mouse acceleration and speed.

Sets the screen cursor tracking speed when in mouse mode.

Sets the screen cursor acceleration when in mouse mode.

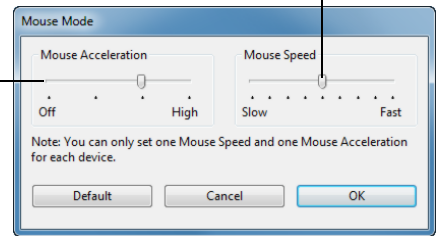

Mouse mode settings can be accessed from a number of different locations within the control panel. However, only one MOUSE ACCELERATION and SPEED setting can be made for each tool and application that you are customizing.

The mouse mode settings are independent of system settings. Changes you make to these settings in the Wacom Tablet control panel do not affect similar system settings. However, changes made to similar system settings may affect your Intuos pro tablet settings.

FUNCTION NAME

DESCRIPTION

ERASE

Sets a button so that when the button is pressed, the pen tip will act like the eraser in applications that support the ERASE function. See [Tablet controls](#).

SETTINGS

Activates (on your display screen) an interactive diagram of the current ExpressKey, Touch Ring, pen, and touch settings. The current functions for each control are shown.

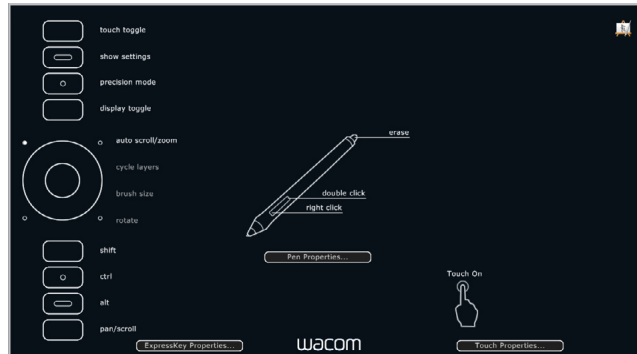

Click on any section of the diagram to open the appropriate Wacom Tablet control panel tab. You can then adjust settings as needed.

Dismiss the diagram by again pressing the ExpressKey or other tool button to which this function is assigned, or by clicking anywhere outside of the diagram.

Settings may vary depending on your tablet model.



FUNCTION NAME	DESCRIPTION
TABLET PC	
• TABLET PC INPUT PANEL	(Tablet PCs and Windows systems that support the Tablet PC Input Panel.) Opens the Tablet PC Input Panel when you press a tool button set to this function.
• JOURNAL	(Windows 7 and Vista, and Tablet PC systems that include Microsoft Journal.) Opens Microsoft Journal.
• TABLET PC DEFINED	(Tablet PCs and Windows systems that support the Tablet PC Input Panel.) Sets the button function according to settings found in the Windows 8, Windows 7 and Vista TABLET PC SETTINGS and PEN AND INPUT DEVICES control panels.
DISABLED	Disables the button function.
APPLICATION DEFINED	Reports only the button number to the application. This is for applications, such as CAD programs, that have built-in tablet support. This function may also be used by some highly integrated applications for direct control of the tablet ExpressKeys and Touch Ring.
SKIP	Sets the Toggle Button to skip a function mode that has been assigned this option in the toggle sequence.
DEFAULT	Returns a button to its default setting.



USING AND CUSTOMIZING THE RADIAL MENU

The Radial Menu is a pop-up menu that provides quick access to editing, navigation, media control functions, and more.

- Set a tool button or ExpressKey to the RADIAL MENU function. Press the button to display the Radial Menu centered at the screen cursor position.
 - You can also use the appropriate touch gesture to open the Radial Menu.
 - The hierarchical Radial Menu appears in circular format. Each level of the menu consists of eight control slices which may contain various features and options to choose from.
 - Click to select an option. Some selections may display a submenu for additional options.
 - The menu closes after you make a selection.
- To close without making a selection, click on the 'X' located at the center of the Radial Menu or on a control slice that has no function assigned to it. You can also again press the button used to display the menu.
- To make a selection without closing the Radial Menu, hold down the button that opens the menu.

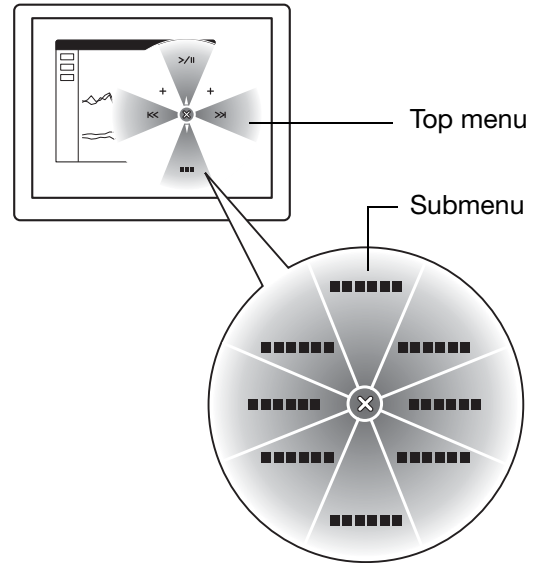

In the Wacom Tablet control panel, use the RADIAL MENU tab to customize the available Radial Menu functions.

1. Select a control slice.
2. Assign a control FUNCTION to the slice. If desired, change the LABEL name.
3. Select a menu or submenu to further customize.

Tips:

- In the FUNCTION menu, choose SUBMENU to create custom submenus for a control slice.
- Press the ENTER (RETURN) key to add multiple lines of LABEL text.

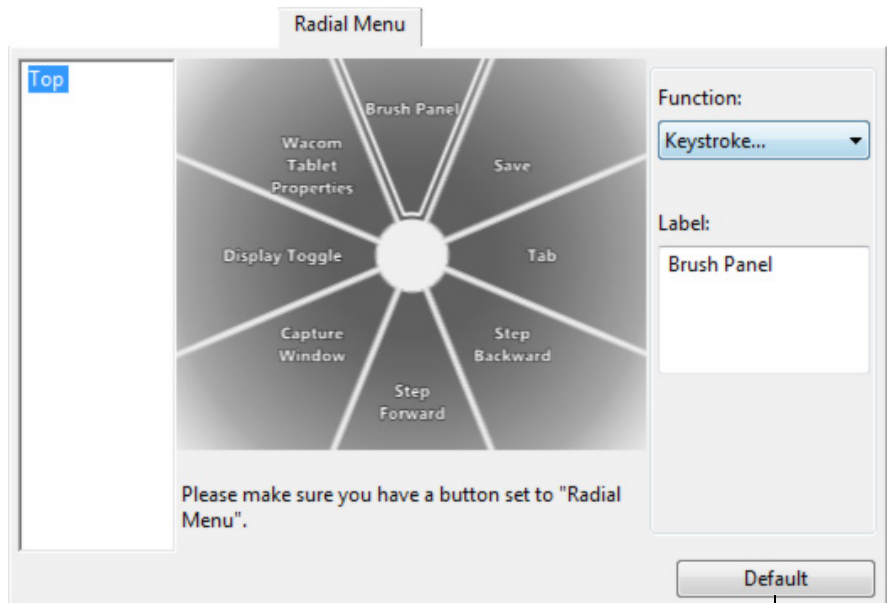

Returns the currently displayed menu to its default values.

WORKING WITH DISPLAY TOGGLE

Display Toggle is available when working on multiple monitor systems. This feature allows you to work with your tablet on all displays or on one display at a time. See [Working with multiple monitors](#).

In the Wacom Tablet control panel, the DISPLAY TOGGLE tab is automatically available when the Intuos pro tablet is installed on a multi-monitor system. This tab lets you set which monitor(s) will be included in the toggle sequence.

After setting an ExpressKey or pen side switch to DISPLAY TOGGLE, you can use that button to sequentially toggle the current tablet mapping between a base mapping (the current setting from the [MAPPING](#) tab) and other monitors. For example:

1. The entire display area of a multi-monitor system is set up for extended mode and assigned to the active area of the Intuos Pro tablet.
2. Pressing a tool button to which the DISPLAY TOGGLE function has been assigned toggles the tablet mapping to the next display in sequence.

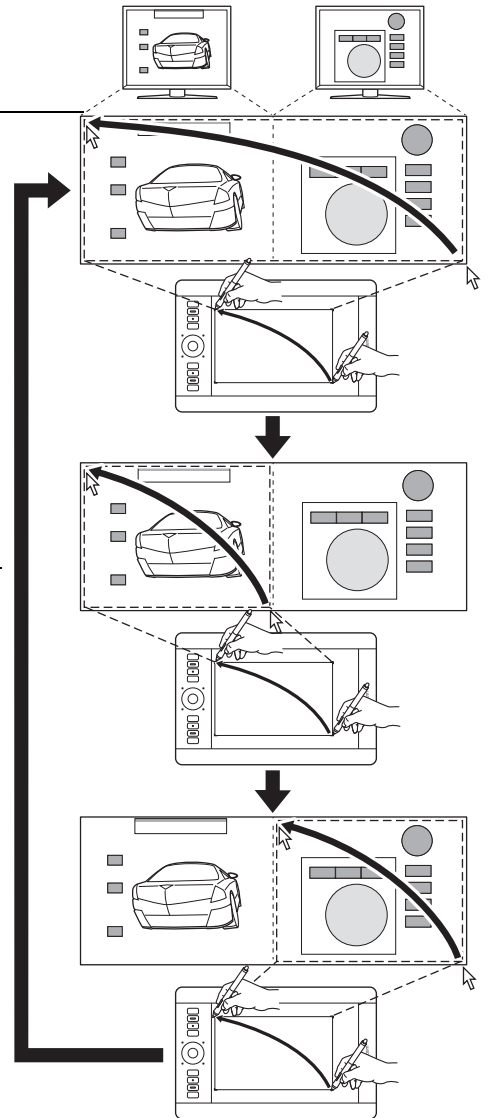

All monitors are selected in the toggle sequence by default. Uncheck any monitor you want removed from the sequence.

- The base mapping is the tablet and display mapping that is defined in the [MAPPING](#) tab.

By default, this includes all monitors unless you have defined a specific monitor as your primary monitor.

- As you toggle to the next monitor, the active tablet area is mapped to that monitor (in pen mode).
- Toggling one more time after the last selected monitor returns the system to the base mapping.

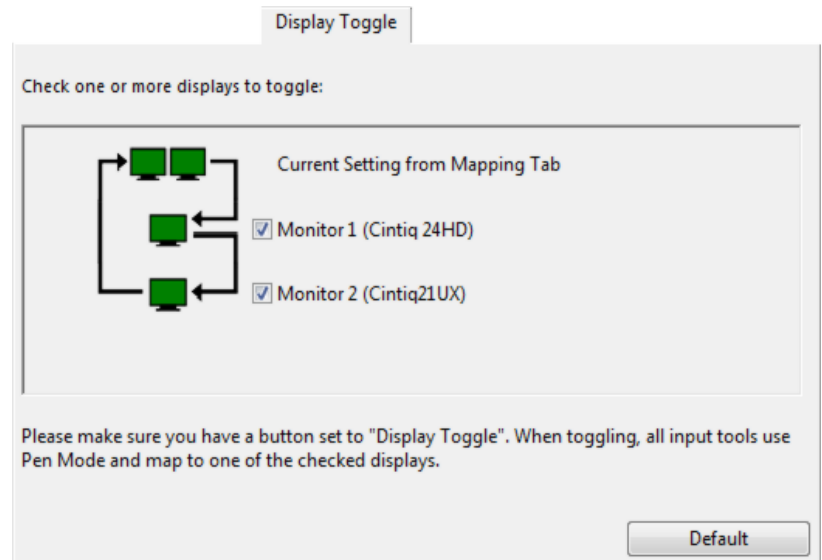

Important: When using application-specific settings with DISPLAY TOGGLE, be sure that each customized application in the APPLICATION list (including ALL OTHER) has a tool button assigned to DISPLAY TOGGLE. The easiest way to do this is to assign DISPLAY TOGGLE to an ExpressKey prior to creating any application-specific settings.

Any of the following actions will return the toggle sequence to the base mapping:

- Launching a graphics application that supports pressure sensitivity.
- Logging out of or rebooting the system.
- Switching users (Fast User Switching).
- Placing the system in sleep mode.
- Changing the [MAPPING](#) or DISPLAY TOGGLE settings.
- Changing the resolution or number of displays on your system.
- Using the [MODE TOGGLE...](#) function.
- Selecting PEN MODE or MOUSE MODE from the [Radial Menu](#).

Tip: To toggle between monitors without including the 'full display' option, disable the first display on the DISPLAY TOGGLE tab. Then go to the MAPPING tab and set the current SCREEN AREA to the first display.

APPLICATION-SPECIFIC SETTINGS

You can customize your tools for use with a particular application. For example, you may prefer a firm pen tip pressure setting in one application and a soft pressure setting in another. The APPLICATION list enables you to add an individual application to the list and then customize your tool settings for that application.

- When no application-specific settings are in use and a tool is selected from the TOOL list, the APPLICATION list displays the ALL icon, which contains tool settings that apply to all of your applications. In the example below, no application-specific settings have been added for the GRIP PEN. The ALL icon is displayed and the GRIP PEN will have the same settings in all applications.



- When application-specific settings are added, or when automatic default setting from the driver are in effect, the ALL icon changes to ALL OTHER, and an application icon is displayed for the newly added application(s).

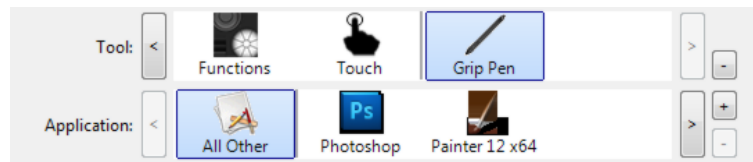

In the above example, application-specific settings have been added for the GRIP PEN. If you select the ALL OTHER icon and make changes to the GRIP PEN settings, your changes will apply to the GRIP PEN in all applications except those which you have added to the APPLICATION list. If you select an application icon and make changes to the GRIP PEN settings, your changes will apply to the GRIP PEN while you are using that application only.

When you create application-specific settings, you are creating a separate group of settings for the selected tool and application.

Tip: To review the ExpressKey, Touch Ring, or pen settings for the front-most application, set an ExpressKey to [SETTINGS](#) and press the key at any time.

See the following sections for more details:

[Creating an application-specific setting](#)

[Removing application-specific settings](#)

CREATING AN APPLICATION-SPECIFIC SETTING

First choose the TABLET and TOOL for which you want to create an application-specific setting.

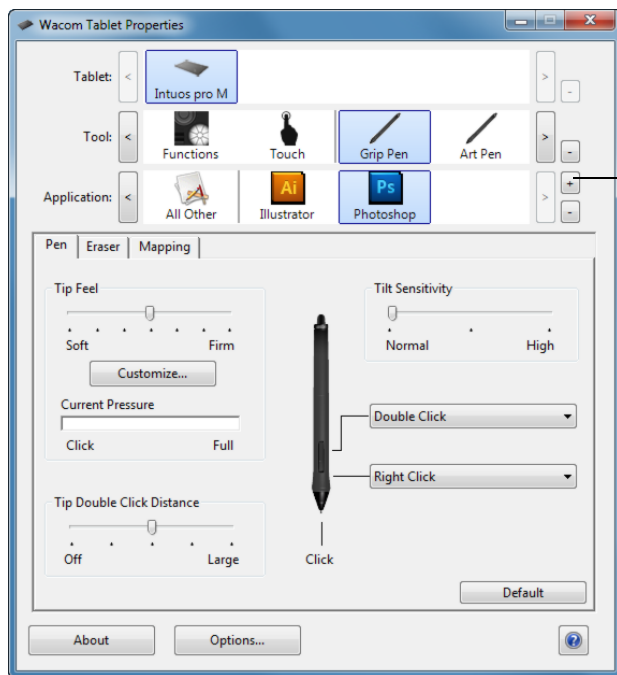

Click on the APPLICATION list [+] button.

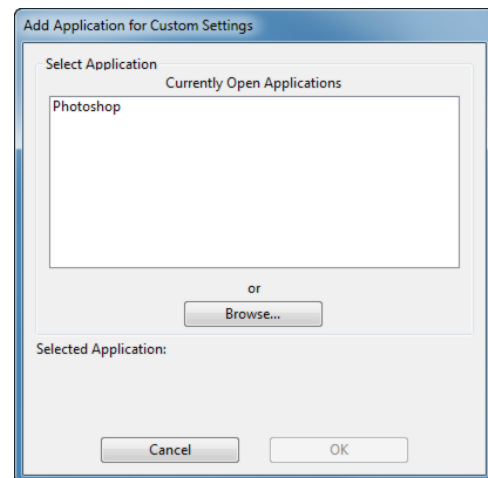

Choose a method to select an application:

- In the CURRENTLY OPEN APPLICATIONS box, select an application for which to create custom settings.
- BROWSE to select the executable file of any application installed on your computer. The name of your selected application is displayed.
- Click OK to complete the process.

Note: If two programs have the same executable file name, they will share the same customized settings.

After adding an application, its icon appears in the APPLICATION list whenever the respective tool is selected in the TOOL list. Select the application and then customize the control panel tab settings for your tool and selected application.

Once you have created application-specific settings, applications that have not been customized in this manner will use the tool settings for ALL OTHER.

REMOVING APPLICATION-SPECIFIC SETTINGS

To remove an application-specific setting:

1. In the TOOL list, select the tool from which you want to remove the application-specific setting.
2. In the APPLICATION list, select the application you want to remove from the list.
3. Click on the APPLICATION list [-] button. In the dialog box that appears, click DELETE to confirm your selection. The selected application is removed from the list, along with any custom tool settings.

Tip: To quickly remove all application-specific settings from a single tool, remove it from the TOOL list. Then place the tool back on the tablet. The tool will be added back to the TOOL list using the default settings. This method cannot be used to remove custom FUNCTIONS settings.



WORKING WITH MULTIPLE TOOLS

The Wacom Tablet control panel is designed to help you customize and keep track of the settings for your tablet and [Intuos pro tools](#). The tool you use to open the control panel is automatically selected, and the appropriate tabs for that tool are displayed.

The TOOL list displays an icon for the tablet FUNCTIONS and different tools that have been used on the tablet.

The TOUCH icon is available for touch-sensitive tablets. See [Setting the touch options](#).

If application-specific settings have not been added, the ALL icon is displayed and the tool settings apply to all applications.

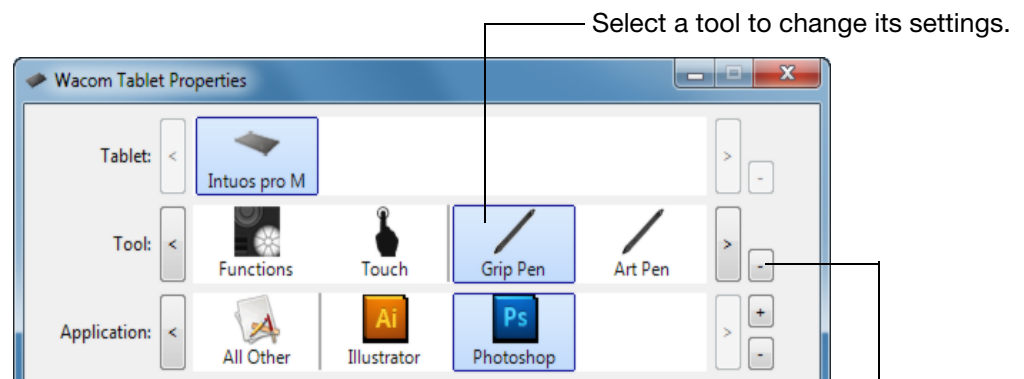

Removes the selected tool. The button is inactive when there is only one item in the list. The FUNCTIONS and TOUCH icons cannot be deleted.

To add a different tool to the TOOL list, simply use the tool on your Intuos pro tablet.

- When you select a tool that has been added to the TOOL list, the appropriate tab settings for that tool are displayed. Any changes you make to the tab settings will then apply to the tool.
- If a similar tool was previously added, the new tool will inherit the settings of the previously added tool. These settings can then be customized for the newly added tool. Identical tools will use the same settings.

To remove a selected tool from the TOOL list, click on the TOOL list [-] button. In the dialog box that appears, click DELETE to confirm your selection. The selected tool is removed from the list, along with any custom settings you may have created for it. A removed tool can be added back to the TOOL list by placing it back onto the tablet.

CHANGING THE TABLET MODE

Intuos pro is configured for optimum performance in most applications. However, some handwriting recognition software requires a higher data rate than is typically needed for most applications. This higher data rate can slow computer performance in some circumstances. If your recognition software does not work well, you can change the tablet mode from standard to recognition mode.

Within the control panel TABLET list, double-click on the tablet icon. The TABLET MODE settings apply to all tools and applications.

If desired, enter a new name for the tablet icon.

STANDARD MODE is recommended for graphics applications.

Choose RECOGNITION MODE for the maximum data rate. Required by some handwriting recognition software.

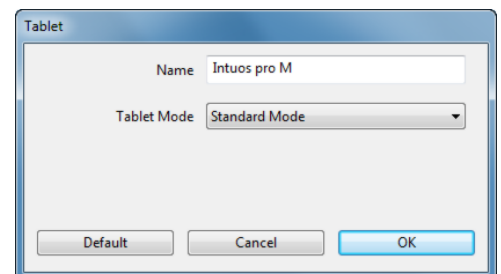

ADVANCED OPTIONS

Click on the Wacom Tablet control panel **OPTIONS...** button to access the advanced **OPTIONS** dialog box.

You can change the **SIDE SWITCH MODE** to best fit the way you like to use the pen when making right-clicks or other click functions.

Select:

- **HOVER CLICK** to perform click functions without touching the pen tip to the tablet surface. This is the default setting for all except Tablet PCs.
- **CLICK & TAP** to enable the precise placement of click functions. When selected, you must first press the side switch then touch the pen tip to the tablet surface in order to perform the function.



Hover click



Click tap

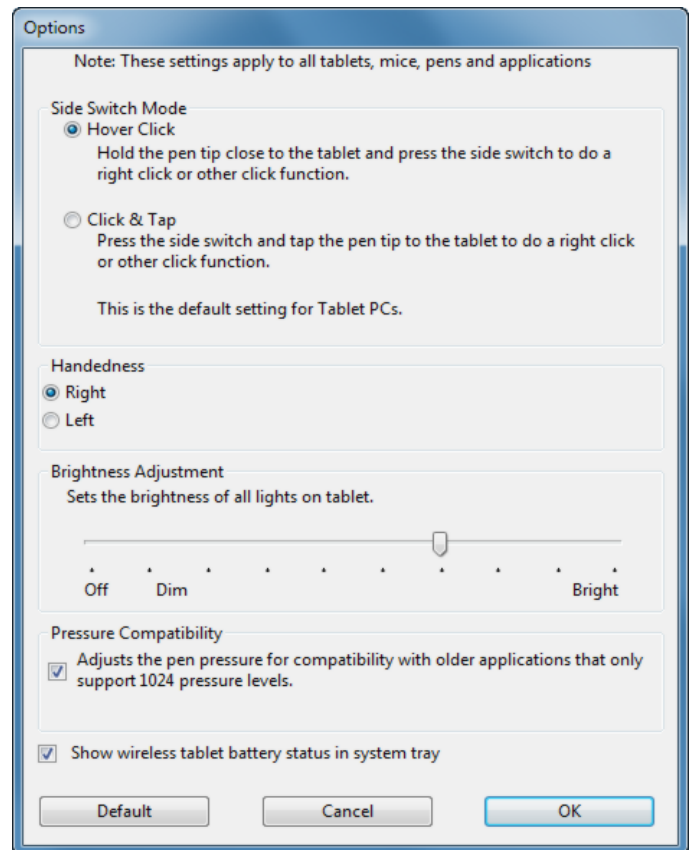

- **MOUSE HANDEDNESS** options change the button orientation of the optional Mouse for right- or left-handed use.
- Use **BRIGHTNESS ADJUSTMENT** to set the brightness level or turn off all Touch Ring status LEDs and active area markers.
- The **PRESSURE COMPATIBILITY** check box should be checked if you are using graphics applications that only support a maximum of 1024 levels of pressure (such as Adobe CS3, Corel Painter 9, and other older applications). If not checked, the pen will feel overly sensitive when using these older applications.
- Check the last box to enable or disable display of the battery status icon in your system tray.



MANAGING PREFERENCES

Use the Wacom tablet preferences utility to manage your tablet preferences for single or multiple users.

Windows 8: From the Windows 8 Start screen, click the WACOM TABLET PREFERENCE FILE UTILITY tile. If you are using Windows 8 Classic Desktop, press the Windows key on your keyboard, or select the Windows icon in the Charms bar, to access the Start screen.

Windows 7 and Vista:

1. Click the START icon and select ALL PROGRAMS.
2. Select WACOM and WACOM TABLET PREFERENCE FILE UTILITY.

For all Windows systems, set your preferences as follows:

1. Close any open applications.
2. Set your preferences as follows:
 - Carefully follow any prompts that may appear
 - To back up your preferences, click BACKUP... under MY PREFERENCES.
 - To restore preferences that you had previously backed up, click RESTORE... under MY PREFERENCES.
 - To remove preferences for the current user, click REMOVE under MY PREFERENCES.
 - To delete preferences for multiple users, click REMOVE under ALL USER PREFERENCES.
Note: Administrator rights are required to delete preferences for all users.

Relaunch any currently open tablet-aware applications that you may be running.

For Mac: Open the main APPLICATIONS folder. Then open the WACOM TABLET folder and run the WACOM TABLET UTILITY.

- Carefully follow any prompts that may appear
- To back up your preferences, select CURRENT USER, then click BACKUP....
- To restore preferences that you had previously backed up, select CURRENT USER, then click RESTORE....
- To remove preferences, select Current User, or All Users, then click REMOVE.
Note: Administrator rights are required to delete preferences for all users.

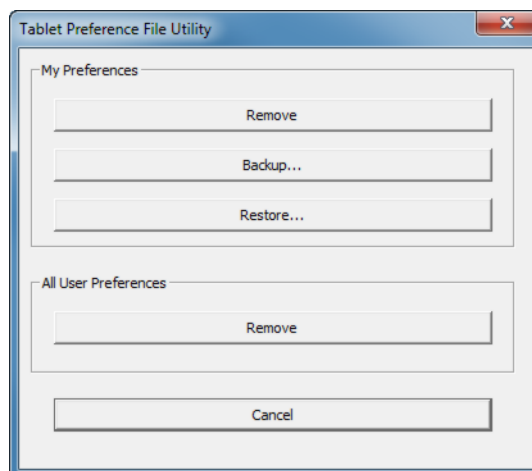

GOING WIRELESS WITH INTUOS PRO

Intuos Pro tablets are designed to let you go wireless by adding the Wacom wireless accessory kit.

WIRELESS ACCESSORY COMPONENTS

The Wacom wireless accessory kit includes the following components:

Power button

Battery status LED

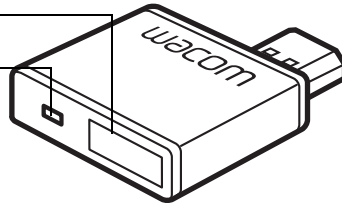

Wacom wireless module
Plugs into Intuos Pro tablet.

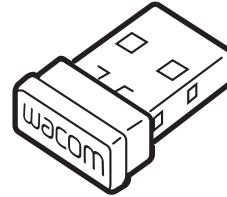

Wacom wireless receiver
Plugs into computer.

When not in use, can be stored within the Intuos Pro tablet. See [Wireless receiver storage](#).

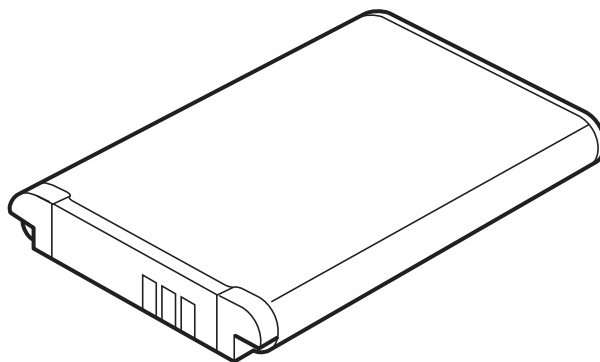

Rechargeable battery, Lithium-Ion (Li-Ion)
Installs within the Intuos Pro tablet.



Warning: See the Important Product Information guide for safety precautions. Located on the Intuos Pro installation CD.

Note: The wireless module and receiver are factory paired. If lost or broken, you will need to purchase a new wireless accessory kit. The battery can be purchased separately.

To install the kit, see [Wireless setup](#).

[Wireless setup](#)

[Battery and power management](#)

[Battery life information](#)

[Battery replacement](#)

[Wireless module removal](#)

[Wireless receiver storage](#)

WIRELESS SETUP

Configure Intuos Pro for wireless operation.

1. If you have been using Intuos Pro as a wired tablet, disconnect the USB cable.
2. Turn the tablet over. Remove the wireless compartment cover(s). See (A). Slide cover(s) away from tablet body to remove. Medium- and large-sized tablets are equipped with two covers: one for the Wacom wireless module, and one for the rechargeable battery. Small-sized tablets come with a single cover.
3. Install the wireless components.

- Install the battery. Align contacts (B) as shown and press into place. See also [Battery replacement](#).

Note: Do not press straight down on the battery to install it. Align the contacts and press that end of the battery into place before pressing down the other end.

- Install the wireless module. Lift away and remove the wireless module spacer (C). Slide the wireless module into the tablet, ensuring the connector is fully seated (D).

Important: Save the module spacer. You may need it as a tool for removal of the wireless module. See [Wireless module removal](#).

- Replace the wireless compartment cover(s). Align and slide into place (E).
- Connect the Wacom wireless receiver to an active USB port on your computer or USB hub (F).

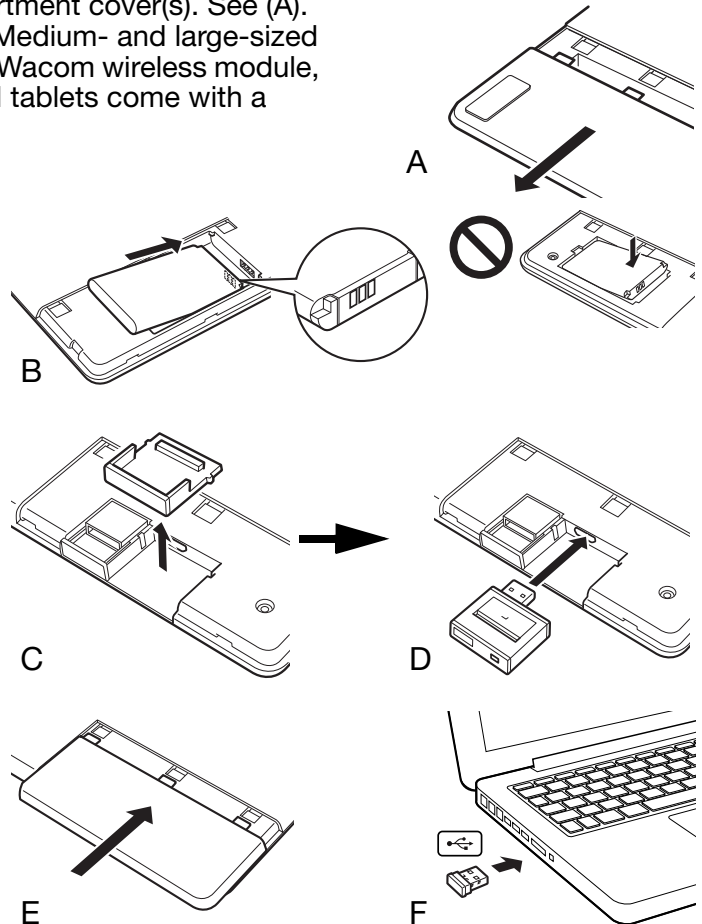

4. If you have not already done so, turn on your computer and wait until the system has fully loaded.
5. Continue to connect wirelessly.

[Establishing a wireless connection](#)

[Optimizing the wireless connection](#)



ESTABLISHING A WIRELESS CONNECTION

Connect wirelessly with Intuos Pro.

1. Fully charge the tablet battery. See [Charging the battery](#). When the battery is fully charged as shown by the green LED, disconnect the USB cable and you are ready to work wirelessly.

Battery status LED

- Amber when USB cable is connected and battery is charging.
- Green when USB cable is connected and battery is fully charged.
- Off when using tablet wirelessly.

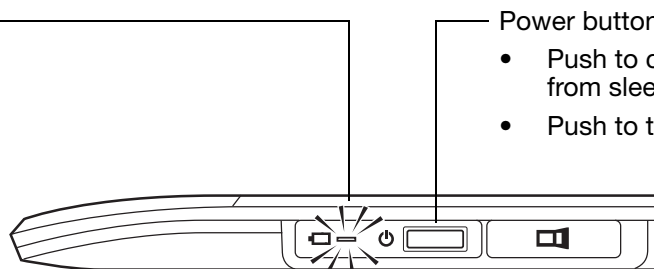

Power button

- Push to connect, or wake from sleep mode.
- Push to turn off.

2. Press the power button on the Wacom wireless module. A wireless connection should be established within 4 seconds. If not, the wireless module will turn off. If this should occur, see [Wireless connection problems](#).
3. Check the connection by using the pen on the tablet to move the screen cursor. See also [Battery and wireless connection status](#).

Intuos Pro can operate wirelessly or in USB mode, but not both at the same time.

- Wireless mode is activated when Intuos Pro is properly configured for wireless operation and the USB cable is disconnected. When the USB cable is disconnected, the tablet searches and connects to the wireless receiver within 4 seconds. If the receiver is not found then the tablet enters sleep mode.
- USB connection deactivates wireless mode, and activates USB mode.

Notes:

[Pairing](#) is not required. The wireless module and Wacom wireless receiver are factory paired and work together as a discrete set.

Intuos Pro can operate wirelessly for up to 10 meters (33 feet) away from your computer. It is not necessary for Intuos Pro to be “in sight” of the wireless receiver. The wireless module uses radio-frequency technology, which can pass through non-metallic objects like desks.

Interference from other devices (especially audio devices) or metallic objects located in or along the line of sight can negatively impact the tablet performance and operating distance. If you experience connection problems, see [Optimizing the wireless connection](#).

When starting up your computer, wait until your operating system has completely loaded and then turn on the wireless module (if not already on) to begin working wirelessly.

Important: The use of wireless devices is regulated in most countries. If Intuos Pro is configured for wireless operation and you will be traveling, check with the appropriate regulatory authority for any restrictions that may apply to your product in the countries that you visit.





 Products using wireless signals may interfere with the equipment on commercial aircraft, and regulations require that all wireless devices be turned off when traveling in an airplane. Turn off the Intuos Pro tablet wireless signal by turning off or removing the wireless module (the tablet status LED(s) will be off) and DO NOT power on the wireless module during takeoff, transit, or landing.

 Do not use Intuos Pro wirelessly in a facility control system or any other environment that requires extremely high reliability, or where the use of a wireless device may cause interference. Wireless operation may interfere with or cause other electronic devices to malfunction, or other wireless devices may interfere with or cause the tablet to malfunction. Where use of wireless products is prohibited, power off or remove the wireless module (ensuring the wireless signal has been turned off) to prevent the possibility of it interfering with or causing other electronic devices to malfunction. Wacom does not accept any liability for direct or consequential damages. For details, please refer to your Warranty, located within the Important Product Information guide.

 Power off your tablet in locations where/when electronic devices are not allowed. Because the tablet may cause other electronic devices to malfunction in some locations where/when the use of electronic devices is not allowed, such as within an airplane, be sure to turn off the tablet by unplugging the USB connector of this product from your computer.

OPTIMIZING THE WIRELESS CONNECTION

If your screen cursor lags behind the pen movement on the tablet or frequently “jumps” about, or if you see excessive straight line segments when drawing in graphics applications, then your wireless connection may not be able to transmit all of the data from the tablet with the necessary speed. This may be caused by interference from other radio sources, obstructions in the radio wave path, excessive distance from the computer, or a combination of the above.

To improve the wireless connection and optimize tablet performance:

- Remove any metallic objects that may be in the line of sight between Intuos Pro and the Wacom wireless receiver attached to your computer.
- Try connecting the wireless receiver to a USB extension cable, and place it on your desktop or somewhere in sight of Intuos Pro.
- Move the tablet closer to your computer.
- Switch off any other devices operating in the 2.4 GHz radio spectrum, such as mobile telephones, etc., or move their antennas further away from your computer.





BATTERY AND POWER MANAGEMENT

This section contains important information about the rechargeable battery and power management features of your Intuos Pro tablet when used wirelessly. Be sure to review the following sections.

[Charging the battery](#)

[Battery and wireless connection status](#)

[Power saving features](#)

CHARGING THE BATTERY

Fully charge the tablet battery before using Intuos Pro for the first time in wireless mode.

Connect the USB cable between Intuos Pro and a primary USB port located directly on your computer, or to a powered USB hub.

- The battery charges whenever the cable is connected and the battery is not fully charged.
- For everyday use, charge your battery in approximately 4 hours. To fully charge an empty battery it takes approximately 6 hours. Actual charge time depends upon battery level and tablet use while charging.
- USB connection deactivates wireless mode.

Important:

- When charging the battery, always connect the USB cable directly to your computer or to a powered USB hub. A non-powered hub may not provide enough current to charge the battery, which may affect overall tablet operation.
- When your tablet is not connected to your computer via USB cable, you can charge the battery using a standard wall adapter with 5V output voltage. Quick charging will not work during this process.

For more information, check the product information on the Wacom web site for your region.



Warning: See the Important Product Information guide for safety precautions.

Tips:

- When charging, be sure that both the battery and the Wacom wireless module are installed in the tablet.
- To check the battery charge status, open the Wacom Tablet control panel, click FUNCTIONS, and select the WIRELESS tab. See [Battery and wireless connection status](#).
- Make the most of your wireless time. See [Power saving features](#) and [Battery life information](#).



BATTERY AND WIRELESS CONNECTION STATUS

When in wireless mode, Intuos Pro provides you with additional feedback about your tablet.

- A tablet status LED shows the following:

Flashing	Wireless mode connecting.
On	Wireless mode on.
Off	Sleep mode, or wireless mode off.

- On the Wacom wireless module, the battery status LED shows the following:

Amber	USB cable connected and tablet battery charging.
Green	USB cable connected and tablet battery fully charged.
Off	USB cable connected, tablet is in USB suspend mode or USB connecting state. USB cable disconnected, no charging activity. USB cable disconnected, operating wirelessly.

- A battery status icon appears in the system task bar (Windows) or menu bar (Mac). Hover the screen cursor over the icon to learn specific details.
- When configured for wireless operation, you can view the tablet battery status and wireless control options using the Wacom Tablet control panel. Open the control panel, click FUNCTIONS and select the WIRELESS tab.

Adjust slider to determine when your tablet will switch to power saving mode.

Battery status icon indicates tablet is in use, and shows an approximation of the battery charge remaining.

- A power plug symbol indicates tablet is running on external power through the USB cable, and the tablet battery is charging.
- A check mark symbol indicates battery is fully charged.
- An alert symbol indicates battery charge is below 20%.

The actual feedback may vary depending on the actual status of your tablet and operating system.

See also [Power saving features](#).

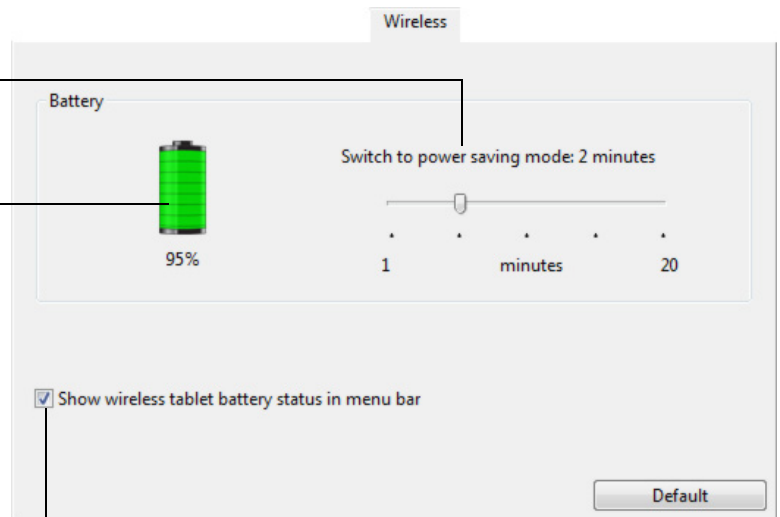

Enables or disables display of the battery status icon.



POWER SAVING FEATURES

When configured for wireless operation, Intuos Pro uses a number of power saving features to conserve the tablet battery charge and improve performance.

Power saving mode Tablet enters power saving mode after 2 minutes of no user input. The time parameter can be adjusted in the Wacom Tablet control panel. See [Battery and wireless connection status](#).
Depending on your tablet model, wake from power saving mode by touching the tablet, pressing an ExpressKey, or placing the pen in proximity.

Sleep mode Tablet enters sleep mode:

- When there is no wireless connection for more than 4 seconds. For example, you switch off the computer, move the tablet out of range, or unplug the wireless receiver. To resume operations, correct any problem and ensure the tablet is within range of your computer. Then press the power button on the Wacom wireless module. See [Testing your tablet](#).
- After 30 minutes of no user input.
- When the battery level is extremely low. Recharge the battery immediately.

To wake from sleep mode, first press the Toggle Button or the power button on the wireless module. Depending on your tablet model, touch the tablet surface with your finger or the pen. Then move your finger or pen along the tablet to fully activate Intuos Pro.

Important: Conserve battery power by turning off the wireless module when you are not using the tablet. Push the power button on the wireless module to turn it off. Otherwise, the tablet battery may need charging before you can again use the tablet wirelessly. See [Battery life information](#).





BATTERY LIFE INFORMATION

When using your Intuos Pro wirelessly, the battery life will vary depending upon usage and your tablet model. For example, you can expect a full day of working charge when using small- and medium-sized tablet models. If you have a large Intuos Pro tablet model, expect a half day of battery charge due to its large size. Wacom recommends purchasing an extra battery. See [Ordering parts and accessories](#).

- All batteries age over time and gradually lose their ability to hold a charge. The typical life span of a Li-Ion battery is two to three years, whether it is used or not. The life and performance of a Li-Ion battery is not improved by cycling (discharging and recharging).
- Always charge the battery whenever the low battery warning appears on your display screen. See also [Power saving features](#).
- The tablet draws current from the battery whenever the Wacom wireless module is on. To reduce power drain, the tablet will enter sleep mode whenever the battery level is very low. The battery must be recharged.

A small amount of current is drawn even in sleep mode, and will slowly discharge the battery. It is a good idea to charge the battery and turn the wireless module off before leaving the tablet unused for a number of days.

- Once the battery voltage has fallen below a minimum safety level, an internal protection circuit within the battery prevents any charging.

If a battery with a low charge remains in the tablet for an extended period of time, the small trickle of current used by the tablet may discharge the battery so far that the internal protection circuit is activated. If this occurs, you can no longer charge the battery. When leaving the tablet unused for an extended period of time, preserve the battery by removing it from the tablet.

You cannot recharge a Li-Ion battery that has been over-discharged.

- For extended battery storage (a month or longer), keeping the battery in a partially (not fully) charged state, along with cool storage, can slow the aging process. The recommended charge level is approximately 40% for optimum battery recharge when placed back into service. If storing both tablet and battery, you do not need to remove the battery. However, it is always good practice to remove the battery when storing the tablet.

Note that you may not be able to recharge the battery after 6 continuous months of non-use.

You will need to purchase a new battery when it is no longer capable of holding an adequate charge or can no longer be charged. See [Ordering parts and accessories](#).



Warning: See the Important Product Information guide for battery safety precautions.



BATTERY REPLACEMENT

If your tablet battery has exceeded its life span and can no longer be charged or no longer holds a charge, it will need to be replaced. Be sure to use only the rechargeable battery designed for your tablet. For information, see [Ordering parts and accessories](#).

Important: Only use a Wacom battery specified for your tablet.

To replace the rechargeable battery:

1. Turn the tablet over. Remove the wireless compartment cover. Medium- and large-sized tablets are equipped with two covers: one for the Wacom wireless module, and one for the rechargeable battery. Small-sized tablets come with a single cover. Slide cover away from tablet body to remove.
2. Carefully remove the old battery as shown below.
3. Install the new battery. Align the terminals of the new battery with the tablet contacts as shown below. Press the battery into the compartment.
4. Replace the wireless compartment cover. Align and slide into place.
5. Connect the USB cable and charge the battery for optimum performance. See [Charging the battery](#).

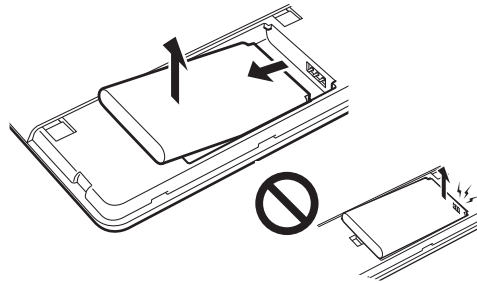
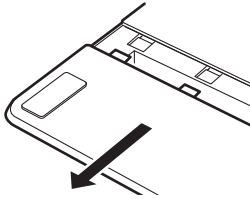

Remove old battery.

Be sure to first lift battery edge before sliding battery out of the compartment.

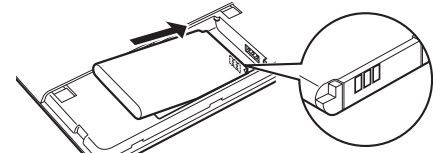

Install new battery.

Carefully install the battery at the angle shown to prevent damaging the battery contacts.

Important: When replacing the battery, be careful not to drop it on hard surfaces. The battery can be damaged internally when dropped, and should be replaced even if there is no obvious damage. This will help prevent any future damage that could occur to the tablet if the battery has been dropped, is installed in the tablet, and then later develops a short or leak while in the tablet.



Warning: See the Important Product Information guide for battery safety precautions.

Many communities offer voluntary or mandatory recycling programs for batteries. Properly recycle the old battery by following all applicable laws, and in accordance with the safety precautions for Lithium-Ion batteries as described in the Important Product Information guide. Keep batteries out of the reach of children. Promptly recycle old batteries.

WIRELESS MODULE REMOVAL

To remove the wireless module:

1. Turn the tablet over. Remove the wireless compartment cover. Medium- and large-sized tablets are equipped with two covers: one for the Wacom wireless module, and one for the rechargeable battery. Small-sized tablets come with a single cover. Slide cover away from tablet body to remove.
2. Use your thumbnail or other suitable, non-metallic tool to unseat the module. You can also use the wireless module spacer that came with your Wacom wireless accessory kit. Place the spacer over the wireless module. Use it as a hook to unseat and slide the wireless module out of the tablet.
3. Press the spacer back into the wireless module slot.

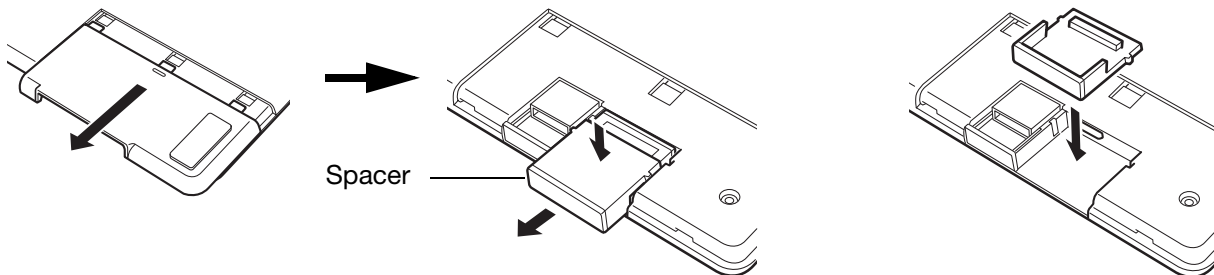

4. Replace the wireless compartment cover. Align and slide into place.
5. Store the wireless module in a safe place after removal.

WIRELESS RECEIVER STORAGE

The Wacom wireless receiver is designed for portability. Plug it into a USB port on your computer. Then leave it there so the receiver will always be available for use with your tablet, even when you are traveling or otherwise on the go with Intuos Pro.

The wireless receiver can also be stored within your Intuos Pro tablet. To store the receiver in the tablet:

1. Use your fingernail or other suitable, non-metallic tool to open the wireless receiver storage compartment.
2. As you open the receiver storage door, slide the wireless receiver spacer partially out of the tablet body.
3. Insert the receiver into the spacer.
4. Slide the spacer fully back into the tablet body and close the receiver storage door.

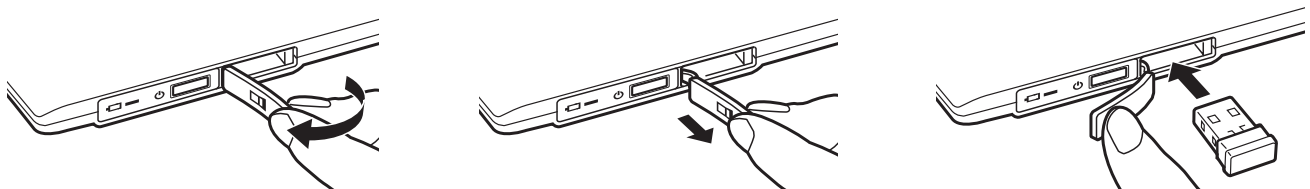

To remove the receiver from the tablet, open the compartment. Slide the spacer partially out of the tablet body. Remove the receiver from the spacer. Slide in the spacer and close the storage door.



TESTING THE WIRELESS CONNECTION

A tablet status LED should glow whenever the tablet is properly connected and your computer has recognized it as a USB device. If you encounter problems with the wireless connection, perform the following checks.

1. First check the general [Troubleshooting](#) procedures.
2. Verify that the wireless module is on. See [Battery and wireless connection status](#).
3. Verify that the wireless module and receiver are properly installed. See [Wireless setup](#).
4. Check the battery power. See [Battery and wireless connection status](#). If the battery charge is low, connect the USB cable and charge the battery. See [Charging the battery](#).
5. Switch the wireless module off, and then back on.
6. Move the tablet closer to the computer. Make sure there are no metal or other high density obstructions in the line of sight between the tablet and computer.
7. Open the Wacom Tablet control panel and click on the ABOUT button. In the dialog box that appears, click DIAGNOSE.... The DIAGNOSTICS dialog box shows dynamic information about the tablet. Check the WIRELESS MODE entry to determine if the wireless status is ON. When you are done, click the CLOSE button to exit the dialog box.

If these tests fail, you may have defective hardware. See .





TROUBLESHOOTING

If you are having trouble, Wacom recommends you do the following:

1. If the tablet driver failed to load properly, first perform the recommended action in any error message that may appear on your screen. If that does not solve the problem, review the troubleshooting procedures in this chapter.
2. Look in the [Troubleshooting tables](#). Your problem may be described there and you can try the solution offered.
3. Visit <http://wacom.com> and choose the Wacom web site for your region to view the product FAQs (Frequently Asked Questions).
4. If you are having a compatibility conflict between Intuos Pro and a new hardware or software product, see for information on downloading an updated software driver. Wacom periodically updates the software driver to maintain compatibility with new products.
5. Test your tablet and Intuos Pro tools. See [Testing your tablet](#) and [Testing the tablet controls and tools](#).
6. If you have tried the suggestions in this manual and still cannot resolve the problem contact Wacom Support. See on how to obtain support for your region.

[Testing your tablet](#)

[Testing the tablet controls and tools](#)

[Troubleshooting tables](#)





TESTING YOUR TABLET

1. Turn on your computer and wait until the system has fully loaded.
2. Check the USB connection. A tablet status LED should glow whenever the tablet is properly connected and your computer has registered it as a USB device. If not:
 - Make sure the tablet USB cable is securely connected to an active USB port on your computer.
 - Check the tablet USB cable for damage.
 - If you are connecting the tablet to a USB hub (or hub device such as a keyboard with USB ports), be sure the USB hub is properly connected to your computer and is active.
 - If a status LED does not illuminate after your computer is on and has finished booting up, your USB port may be disabled. Verify that you have connected the tablet to an active USB port.
 - Connect the tablet to a different USB port or try connecting to the USB port on another computer.
 - For best results when troubleshooting no power to the tablet (a status LED does not light), plug the tablet directly into the system USB port located on your computer. Temporarily eliminate any external hubs in use until you determine that the system recognizes the tablet and that it is functional. When the tablet is working properly, it is usually okay to then move the tablet to a USB hub.
3. For [wireless operation](#), check the tablet connection. A tablet status LED should glow whenever the tablet is properly connected and your computer has registered it as a USB device. If not:
 - Verify that the wireless module is on. See [Battery and wireless connection status](#).
 - Verify that the wireless module and receiver are properly installed. See [Wireless setup](#).
 - Check the battery power. See [Battery and wireless connection status](#). If the battery charge is low, connect the USB cable and charge the battery. See [Charging the battery](#).
 - Switch the wireless module off, and then back on.
 - Move the tablet closer to the computer. Make sure there are no metal or other high density obstructions in the line of sight between the tablet and computer.





4. Check the pen. If the tablet driver does not load properly, the pen will not work properly. (You will be able to use the pen tip to move the screen cursor and click, but there will be no other pen functionality.) Install the tablet driver software.
 - Move your pen across the tablet active area. The screen cursor should move in the corresponding direction on your monitor or display screen.
 - Press the pen tip against the surface of the tablet. A status LED should brighten.
 - Next, without applying pressure to the pen tip, hold the pen tip within approximately 10 mm (0.4 inch) of the tablet surface and press the side switch. The LED should again brighten.
 - Turn the pen over and press the eraser against the surface of the tablet. The LED should brighten.See also [Testing the tablet controls and tools](#) and [Testing a pen](#).
5. Check touch. Attempt to move the screen cursor by tracking your finger across the tablet surface. Then tap to select an item. A status LED should brighten when you touch the active area of the tablet.

If the tablet driver does not load properly, basic touch movement will be recognized, but other actions and gestures will not. If gestures are not recognized, re-install the tablet driver software.
6. Check the ExpressKeys. See [Testing the tablet controls and tools](#) and [testing the ExpressKeys](#).
7. Check the Touch Ring. See [Testing the tablet controls and tools](#) and [testing the Touch Ring](#).
8. Check any other tool(s), such as the optional Mouse for Intuos Pro. See [Testing the tablet controls and tools](#).

If any of these tests fail, you may have defective hardware. See .

After testing, use the Wacom Tablet control panel to reconfigure your tablet and tools for any custom settings you may originally have been using.



TESTING THE TABLET CONTROLS AND TOOLS

If your Intuos Pro tools or tablet controls do not work as you expect, it is a good idea to first check the assigned functions or reset them to their default conditions. You will also want to do this if you have a touch-sensitive tablet model and encounter problems with touch.

A quick way to return a tool to its default condition is to remove it from the control panel TOOL list. Do this by selecting the tool and clicking on the TOOL list [-] button. After the tool has been removed, place it back onto the tablet surface. The tool will be added back to the TOOL list with its default settings.

- Open the Wacom Tablet control panel and click on the ABOUT button. In the dialog box that appears, click DIAGNOSE.... The DIAGNOSTICS dialog box shows dynamic information about the tablet, your tool(s), and appropriate information for touch-sensitive tablets.

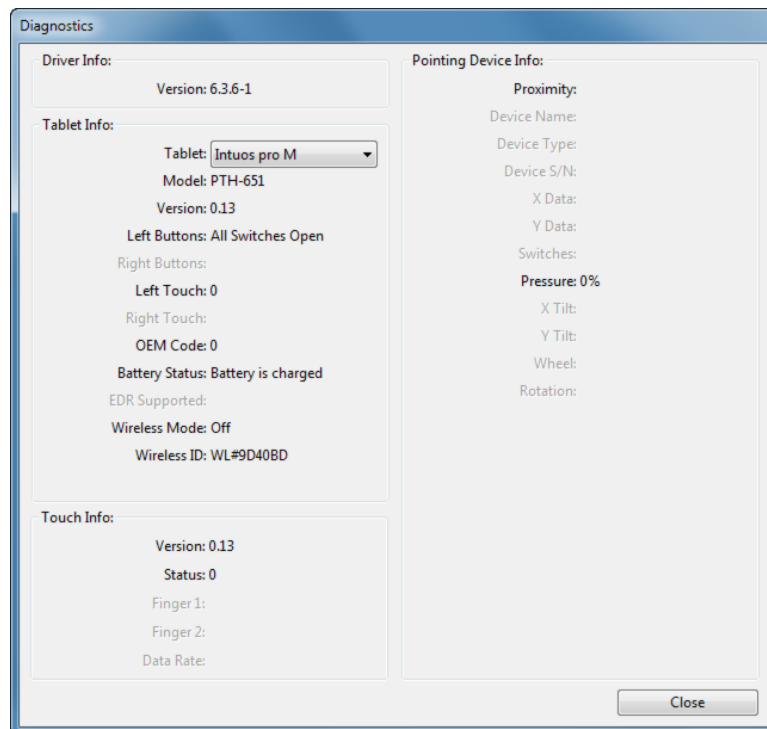

- If more than one tablet is connected to your system, in the TABLET INFO column select the unit for which you are testing.
- Use the information shown in the DIAGNOSTICS dialog box when testing your tablet and tools.

Note: If a tool button is set to RADIAL MENU or OPEN/RUN..., that function will occur when the button is pressed. In this case you may want to change the button function before testing.

[Testing the ExpressKeys](#)

[Testing the Touch Ring](#)

[Testing a pen](#)



TESTING THE EXPRESSKEYS

1. With the DIAGNOSTICS dialog box open, observe the TABLET INFO column as you test each ExpressKey. Be sure to select the tablet unit you are testing from the TABLET INFO column.
2. Test the keys by pressing them one at a time. Each time you press a key, its number is shown next to the LEFT BUTTONS category.
3. When you are done, click the CLOSE button to exit the dialog box.

TESTING THE TOUCH RING

1. With the DIAGNOSTICS dialog box open, observe the TABLET INFO column as you test the Touch Ring. Be sure to select the tablet unit you are testing from the TABLET INFO column.
2. Slide your finger around the entire circumference of the Touch Ring. As you touch and move your finger along the Touch Ring, a LEFT TOUCH number will indicate your current finger position on the Touch Ring.
3. Press the Toggle Button to toggle between the four customizable modes. As you cycle between settings, a corresponding LED should illuminate. Within the DIAGNOSTICS dialog box, the button mode is also shown as LEFT BUTTONS.

If any of the functions are set to SKIP, the corresponding LED will be skipped in the toggle sequence.

4. When you are done, click on the CLOSE button to exit the dialog box.

Important: Some applications can override and control the ExpressKey or Touch Ring functions. Consider closing any open applications except the Wacom Tablet control panel when testing the Touch Ring. For details, see [Using integrated applications](#).





TESTING A PEN

1. With the DIAGNOSTICS dialog box open, and while observing the POINTING DEVICE INFO column, bring your Intuos Pro tool within 10 mm (0.4 inch) of the tablet active area. A value for PROXIMITY, the DEVICE NAME, DEVICE TYPE, and a DEVICE S/N (serial number) should be displayed. If you have more than one tablet connected to your system, be sure you have selected the TABLET for which you are testing your tools from the TABLET INFO column.
2. Move your tool along the tablet surface. The X and Y DATA values should change to reflect the tool position.
3. Test your pen switches. A tablet status LED should brighten each time you click with the tool tip, press the side switch, or press the tool eraser to the tablet.

- Click on the tablet surface with the tool tip. The SWITCHES state and PRESSURE value should change. PRESSURE should change from approximately 0% with no pressure applied to approximately 100% when full pressure is applied.
- Next, press the side switch without pressing the tip to the tablet. The SWITCHES state should change. For the Intuos Pro Pen, do this for both positions of the side switch.

Pen	Tip = 1
SWITCHES states	Side switch (lower position) = 2
	Side switch (upper position) = 3
	Eraser = 1

Airbrush	Tip = 1
SWITCHES states	Side switch = 2
	Eraser = 1

- Press the eraser to the tablet. The SWITCHES state and PRESSURE value should change. PRESSURE should change from approximately 0% with no pressure applied to approximately 100% when full pressure is applied.
 - For the optional Airbrush, move the fingerwheel forward. The WHEEL value should decrease to a value of approximately 0 when the fingerwheel is all the way forward. Move the fingerwheel backward. The WHEEL value should increase to approximately 1000 when the fingerwheel is all the way back.
4. Test tilt for the x-axis by moving the pen from a vertical position toward the right; the X TILT value should change from approximately 0 to +60. Now move the tool to the left of vertical; the X TILT value should change from approximately 0 to -60.
 5. Test tilt for the y-axis by moving the pen from a vertical position toward the bottom of the tablet; the Y TILT value should change from approximately 0 to +60. Now move the tool toward the top of the tablet; the Y TILT value should change from approximately 0 to -60.
 6. For the optional Art Pen, test the rotation feature by placing the pen tip on the tablet surface and slowly rotating the pen on its axis. The ROTATION value should change as you rotate the pen.
 7. When you are done, click on the CLOSE button to exit the dialog box.





TROUBLESHOOTING TABLES

If you encounter problems with your Intuos Pro tools or tablet, see the following tables. Your problem may be described here, and you can try the solution offered.

For additional information, visit the Support page of the Wacom web site at <http://wacom.com>.

[General problems](#)

[Pen problems](#)

[Touch problems](#)

[Wireless connection problems](#)

[Windows-specific problems](#)

[Mac-specific problems](#)

GENERAL PROBLEMS

The computer does not have an available USB port.	Check if there is an available USB port on a USB hub. If not available you will need to add a USB hub or USB card.
A tablet status LED does not illuminate.	<p>Verify that the tablet USB cable is properly connected to the tablet and to an active USB port.</p> <p>If connecting to a USB hub device, make sure the hub is connected to an active USB port and that the hub is active.</p> <p>Try also connecting to another USB port or using another USB cable.</p> <p>If using Intuos Pro in wireless mode, see also Wireless connection problems.</p>
The computer does not go to sleep.	<p>When you are not using your Intuos Pro tool(s), remove them from the tablet surface or the tablet will continue to send data, keeping the computer awake.</p> <p>Note: Because some metallic or other conducting objects can also cause the tablet to send data, it is best to keep the tablet surface clear of all objects when not in use.</p>
The screen cursor is very erratic or “jumps” around when using the tablet.	On rare occasions the tablet may receive interfering radio frequencies from a computer monitor or nearby AM radio station. If you notice interference from a monitor, try moving the tablet at least six (6) inches away from the monitor, or change the monitor refresh rate or monitor resolution.
The tablet is set to EXPRESSKEYS RIGHT (or EXPRESSKEYS LEFT), but at the log on screen the tablet seems to work upside down.	Reinstall the tablet driver software and change the default orientation of the tablet. See Installing the driver .





When working in some applications, the ExpressKeys or Touch Ring perform a different function than what is set in the Wacom Tablet control panel.

Some applications can override and control the ExpressKey and Touch Ring functions. See [Using integrated applications](#).

If using application-specific settings, be sure you have updated the settings for the application you are working with.

PEN PROBLEMS

The pen does not position the screen cursor, or otherwise work properly.

If the tablet driver does not load properly, pen input will not be available.

- You will be able to use the pen tip to move the screen cursor and click, but there will be no other pen functionality.
- For tablet models that combine pen input and touch, basic touch movement will continue to be recognized but other actions and gestures will not.

Install the driver software for the tablet.

The pen does not draw or ink with pressure sensitivity.

Some applications require that you turn on the pressure capabilities within the application or the selected tool before the pen will respond as a pressure-sensitive tool.

Verify also that your application supports pressure sensitivity.

Clicking is difficult.

Try using a lighter TIP FEEL. See [Adjusting tip feel and double-click](#).

Double-clicking is difficult.

Be sure you are quickly tapping the tablet twice in the same place on the tablet active area. Wacom recommends using the side switch to double-click.

Open the Wacom Tablet control panel and go to the PEN tab. Try increasing the TIP DOUBLE CLICK DISTANCE or using a lighter TIP FEEL.

Set an ExpressKey to DOUBLE CLICK and use it to issue double-clicks.

Windows: Try setting your system to launch programs with a single click. See [Clicking](#).

The pen selects everything, will not stop drawing.

Open the Wacom Tablet control panel and go to the PEN tab. Move the TIP FEEL slider toward FIRM, or select CUSTOMIZE... and increase the CLICK THRESHOLD setting. If this does not help, see [Testing the tablet controls and tools](#).

The pen nib may be worn. See [Replacing the pen nib](#).

The eraser selects everything or will not stop erasing.

Open the Wacom Tablet control panel and go to the ERASER tab. Move the ERASER FEEL slider toward FIRM, or select CUSTOMIZE... and increase the CLICK THRESHOLD setting. If this does not help, see [Testing the tablet controls and tools](#).

You notice a screen delay at the beginning of pen or inking strokes.

Open the Wacom Tablet control panel and go to the PEN tab. Try decreasing the TIP DOUBLE CLICK DISTANCE. If that does not work, move the TIP DOUBLE CLICK DISTANCE slider to the OFF position in order to turn off double-click assist.

Try turning off the operating system inking features.





You have to press hard with the pen when clicking, drawing, or writing.

Open the Wacom Tablet control panel and go to the PEN tab. Move the TIP FEEL slider toward SOFT, or select CUSTOMIZE... and decrease the SENSITIVITY and CLICK THRESHOLD settings.

The pen tip does not function.

Be sure you are using only a compatible Wacom pen, such as the pen that shipped with your product, or a Wacom accessory tool specified for use with Intuos Pro. Other pens may not function properly on the tablet.

Check the control panel PEN tab and verify that a CLICK function is assigned to the tip.

A tablet status LED should brighten when the tip is pressed. If not, you may have defective hardware. See [Testing the tablet controls and tools](#).

Changing the settings of the pen or other tool has no effect.

Make sure you are changing the settings for the tool and application that you are using. See [Application-specific settings](#) and [Working with multiple tools](#).

The pen side switch does not work.

Be sure you are using only a compatible Wacom pen, such as the pen that shipped with Intuos Pro or a Wacom accessory tool specified for use with Intuos Pro. Other pens may not function properly on the tablet.

Be sure to press the side switch when the pen tip is within 10 mm (0.4 inch) of the tablet active area. Do this without pressing down on the pen tip.

In the Wacom Tablet control panel, verify that the side switch is set to the function you are expecting to occur for the application and tool you are using.

Check also the SIDE SWITCH MODE. If CLICK & TAP is selected, you will need to first press the side switch while touching the pen tip to the tablet surface in order to perform a click function. See [Advanced options](#).

A tablet status LED should brighten when you press the side switch. If not, you may have defective hardware. See [Testing your tablet](#).

The screen cursor “jumps” back.

Do not place an Intuos Pro tool on the tablet when it is not in use, or when you are using another pointing device. Leaving your tool on the tablet may interfere with screen cursor positioning when using other input devices.

You cannot move the cursor where you want to on the screen, or the line you are drawing does not line up with the location of the pointer in paint applications.

Open the Wacom Tablet control panel and go to the MAPPING tab. Verify that PEN MODE is selected and that the SCREEN AREA is set to FULL for the selected tool and application. If this does not help, click on the DEFAULT button to reestablish tablet to screen mapping. If you are still having difficulty, remove the tablet preferences (see [Windows-specific problems](#) or [Mac-specific problems](#)).

Confirm whether the pen does (or does not) function. See [Testing the tablet controls and tools](#).





When using the pen to operate the Touch Ring, the Touch Ring does not work well.

The Touch Ring is designed to be used with your finger, and does not work with the pen tip.

When using Intuos Pro on a multiple monitor system, you cannot use the pen to control the other monitor(s).

Cycle pen control for Intuos Pro between your displays by pressing an ExpressKey or pen button that is set to [DISPLAY TOGGLE](#).

Verify that the SCREEN AREA in the MAPPING tab is set to FULL.

You can also use your pen to control the other monitors in mouse mode. To use mouse mode, first set a pen button to MODE TOGGLE.... Then use the button to toggle between PEN MODE and MOUSE MODE.

TOUCH PROBLEMS

Touch does not work.

Enable touch by pressing an ExpressKey that is set to TOUCH ON/OFF. Otherwise, open the Wacom Tablet control panel, click on the TOUCH icon, and go to the STANDARD GESTURES, MY GESTURES, or TOUCH OPTIONS tab. Be sure the ENABLE TOUCH option is selected.

Touch does not seem to fully work. The screen cursor can be moved, but more complex actions or gestures do not work.

If the tablet driver does not load properly, basic touch movement will be recognized but other actions and gestures will not. Install the driver software for the tablet.

The tablet does not reliably recognize multi-finger touch.

If you hold your fingers too close together, the tablet may not recognize them as being separate. Try moving your fingers a little further apart.

Cannot zoom-in or zoom-out when working with Adobe Photoshop.

If zoom functions do not operate correctly within Photoshop, verify that the ZOOM WITH SCROLL WHEEL function is not selected within the Photoshop PREFERENCES options.

Scrolling and panning gestures do not function correctly when working with Adobe Photoshop.

If touch gestures do not operate correctly within Photoshop, verify that the ZOOM WITH SCROLL WHEEL function is not selected within the Photoshop PREFERENCES options.

Rotation gestures do not seem to work consistently, or not at all.

Rotation may work differently depending on the application you are working with. For example, rotation may work smoothly in 90-degree increments or not at all.

For best recognition of this gesture, start with your fingers positioned diagonally on the tablet surface and keep them at least 25 mm (1 inch) apart.

WIRELESS CONNECTION PROBLEMS

The computer does not have an available USB port.

Check if there is an available USB port on a USB hub. If not available, add a USB hub or USB card.





After pressing the power button on the wireless module, a tablet status LED glows steadily for 4 seconds and then turns off.

If a wireless connection is not established, the wireless module will turn off after 4 seconds.

- Make sure the wireless receiver is properly connected to an active USB port on your computer or USB hub.
- Move the tablet closer to the antenna and make sure there are no metal or other high-density obstructions in the line of sight between the tablet and your computer.

Again press the power button to activate the connection.

After turning on the wireless module, a status LED indicates good functionality but the screen cursor cannot be moved.

If your tablet model supports touch, be sure you have not turned off touch.

Be sure you are using the pen correctly. Review [using the Grip Pen](#).

Switch the wireless module off, then back on.

If the battery charge is low, try [Charging the battery](#).

A wireless connection has been made, but the tablet does not seem to work correctly.

Be sure you have correctly installed the tablet driver software.

See also [Optimizing the wireless connection](#).

The tablet works when connected with the USB cable, but turns off as soon as the cable is disconnected.

Confirm the wireless module and receiver are correctly installed, and that the wireless module is turned on.

Check the battery. See [Battery and wireless connection status](#).

- Open the tablet wireless compartment cover and verify that the battery is properly installed.
- Check the battery appearance to ensure there is no leakage or other indication of damage.
- Charge the battery overnight and try again. If the problem persists, the battery may be completely discharged or damaged and can no longer hold a charge. You will have to purchase a replacement battery. See [Ordering parts and accessories](#).





The wireless LED does not illuminate after pressing the power button on the wireless module.

Try again. Then:

1. Verify the Wacom wireless receiver is properly connected to an active USB port. If connecting to a USB hub, make sure the hub is connected to an active USB port and that the hub is active.
2. Verify the Wacom wireless module is properly installed in the tablet. Press the power button to connect wirelessly.
3. If the LED still does not light, connect the USB cable between your tablet and computer.

On the wireless module, check the battery status LED.

Amber indicates the battery is charging. Green indicates the battery is fully charged. If the LED remains off, the battery may be defective. Replace the battery.

4. If both the tablet status and wireless module LEDs remain off, then contact the Wacom support staff for the area where your product was purchased. See .

When using the tablet, the screen cursor or pen strokes seem to lag or skip in some applications.

See [Optimizing the wireless connection](#) for tips on improving the connection.

The battery charging process seems to stop whenever the computer enters sleep mode.

As required, adjust your system power or energy saver settings so that the computer does not enter sleep mode while the tablet battery is charging.





WINDOWS-SPECIFIC PROBLEMS

You suspect the tablet preferences may be corrupted, or want to make certain that all settings are at their factory defaults.

Use the Wacom Tablet Preference File Utility to work with preferences. Close any open applications. Click the START icon and select ALL PROGRAMS. Then select WACOM TABLET and WACOM TABLET PREFERENCE FILE UTILITY.

- It is a good idea to first back up your tablet preferences. In the TABLET PREFERENCE FILE UTILITY dialog box, click BACKUP... and follow the prompts.
- Then use the Tablet Preference File Utility to delete the tablet preferences as follows:
 - Single user. Under MY PREFERENCES, click REMOVE to delete the preferences for the current user.
 - Multiple users. Under ALL USER PREFERENCES, click REMOVE to delete preferences for multiple users. Administrator rights are required to delete preferences for all users. Relaunch any currently open tablet-aware applications that you may be running.

You can quickly restore tablet preferences that have been backed up by clicking RESTORE... under MY PREFERENCES.





MAC-SPECIFIC PROBLEMS

At startup, a dialog box appears telling you that either the driver failed to load or the tablet preferences have not yet been created.

The tablet was not detected at startup.

If using a wireless connection:

- Make sure the wireless connection is active. See [Battery and wireless connection status](#).
- From the GO menu, select UTILITIES and launch the SYSTEM PROFILER. Select USB from the HARDWARE section of the CONTENTS list. A Wacom USB tablet model should be listed. If a tablet model is not listed, check the wireless connection.

If connected with the provided USB cable:

- Make sure the USB cable is securely connected to an active USB port on your computer or USB hub. Check to be sure that a tablet status LED is illuminated. If your tablet is plugged into a USB hub, make sure the hub is connected and active.
- From the GO menu, select UTILITIES and launch the SYSTEM PROFILER. Select USB from the HARDWARE section of the CONTENTS list. A Wacom USB tablet model should be listed. If a tablet model is not listed, check the USB tablet cable connection or try plugging the tablet into a different USB port.

If you are still having difficulties, uninstall then reinstall the tablet driver software.

If this does not help, contact Wacom for Technical Support. See .





You suspect the tablet preferences may be corrupted, or want to make certain that all settings are at their factory defaults.

Use the Wacom Tablet Utility to work with your preferences. Close any open applications. Open the main APPLICATIONS folder. Then open the WACOM TABLET folder and run the WACOM TABLET UTILITY.

- It is a good idea to first back up your tablet preferences. In the Wacom Tablet Utility, select CURRENT USER or ALL USERS. Then click BACKUP... and follow the prompts.

- Then, delete the tablet preferences as follows:

Single user. When the utility starts, select CURRENT USER and click REMOVE. Log out, then log back in. When the tablet driver loads it will create a new preferences file with the factory defaults.

Multiple users. When the utility starts, select ALL USERS and click REMOVE. Log out, then log back in. When the tablet driver loads it will create new preferences files with the factory defaults.

You can quickly restore tablet preferences that have been backed up for the CURRENT USER or ALL USERS by clicking RESTORE... within the utility.

Note: Do not manually remove the WACOM TABLET.PREFPANE file from the main LIBRARY PREFERENCE PANES folder. This file is only to be removed when uninstalling the Wacom software driver, and then only when using the Wacom Tablet Utility.

Ink does not work correctly with Intuos Pro.

There may be a problem with the Ink preferences. Remove the damaged preference files as follows. They will be re-created when you enable handwriting recognition.

1. Open SYSTEM PREFERENCES, choose SHOW ALL and select INK. Then turn off handwriting recognition.
2. From the GO menu, choose your HOME. Open the LIBRARY and PREFERENCES folders. Remove the following preferences:
 - COM.APPLE.INK.FRAMEWORK.PLIST
 - COM.APPLE.INK.INKPAD.PLIST
 - COM.APPLE.INK.INKPAD.SKETCH
3. Go back to SYSTEM PREFERENCES and INK, and then enable handwriting recognition.
4. Test the Ink function using your Wacom tablet and pen.

If this procedure does not resolve your problem with Ink, contact Apple Support for further assistance. Wacom is not the software manufacturer for Ink and we are limited in our abilities to support a third-party software application.





TECHNICAL SUPPORT OPTIONS

If you have a problem with your tablet, first check the tablet installation guide to be sure the unit is installed correctly. Then review the [Troubleshooting](#) procedures.

If you cannot find the answer in this manual, you may find updated information about your problem in the appropriate Notes file for your platform (located on the Intuos Pro installation CD). You can also visit <http://wacom.com> where you can choose the Wacom web site for your region and check the product FAQs (Frequently Asked Questions).

If you have an Internet connection you can download the latest software drivers from the Wacom web site for your region. See .

If you cannot solve the problem and you think your tablet is not working properly, contact Wacom Support for the area where your product was purchased.

When you call, you should be at your computer with the following information available:

- This manual.
- Tablet serial and model number. (Located on the bottom of the tablet.)
- Driver version number. (See the Intuos Pro installation CD or click on the Wacom Tablet control panel ABOUT button.)
- The make and model of your computer, and operating system version number.
- A list of peripheral devices attached to your computer.
- The software application and version you were using when the problem occurred.
- The exact wording of any error message that appeared on your screen.
- What happened and what you were doing when the problem occurred.
- How you tried to solve the problem.

You can also contact Wacom Support by visiting the Wacom web site for your region and completing an Email Inquiry form.

OBTAINING SOFTWARE UPDATES

Wacom periodically updates the tablet software driver to maintain compatibility with new products. If you are having a compatibility problem between Intuos and a new hardware or software product, it may be help to download a new software driver (when available) from the Internet.

Visit <http://wacom.com> for support, product drivers, or other software updates.

CARE AND MAINTENANCE

Keep the pen and the Intuos surface clean. Dust and dirt particles can stick to the pen and cause excessive wear to the surface. Regular cleaning will prolong the life of your surface and pen.

Store your Intuos and pen in a clean, dry place and avoid extremes in temperature. Room temperature is best for tablet use and storage.

Do not disassemble the Intuos or the pen. Taking apart the product will void your warranty.

Important: Take care to never spill liquids onto the Intuos or the pen. Be especially careful of getting the display, ExpressKeys or pen buttons and pen tip wet, as they contain sensitive electronic parts that will fail if they are exposed to liquids.

Avoid scratching the Intuos Pro with a worn pen nib by replacing your nibs frequently. See [Replacing the pen nib](#).

To clean the Intuos Pro or the pen, use a soft, damp cloth. You can also dampen the cloth using a very mild soap diluted with water. Do not use any other substances, liquids or solvents to clean the tablet or pen.

To clean the Intuos surface, use an anti-static cloth or a slightly damp cloth. Apply light pressure, and do not make the surface wet. Do not use any type of detergent to clean the Intuos, as it may damage the surface. This damage is not covered by the warranty.



APPENDIX

This section contains tips on caring for Intuos Pro, instructions on how to uninstall the tablet software, information about digital inking, and more.

[Replacing the pen nib](#)

[Uninstalling Intuos Pro](#)

[Installing multiple tablets](#)

[Using integrated applications](#)

[Importing expert settings](#)

[Using the optional Airbrush and Art Pen](#)

[Using the optional mouse](#)

[Product information](#)

[Ordering parts and accessories](#)

[Warranty Service](#)

REPLACING THE PEN NIB

To protect your tablet from scratching and for best performance, periodically replace your pen nibs.

Important: Replace the pen nib before or when it looks like this:

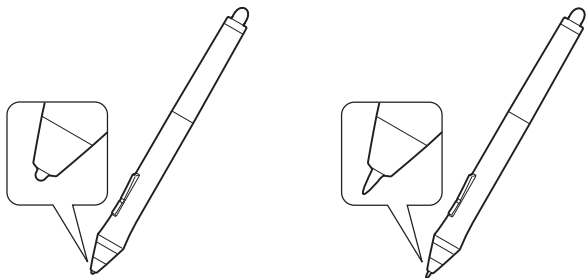

The pen nib (tip) will wear with normal use.

Excessive pressure will cause it to wear sooner.

Replace the nib when it gets too short or develops a flat point.

1. Unscrew the pen stand base to access the nib removal tool and replacement nibs.

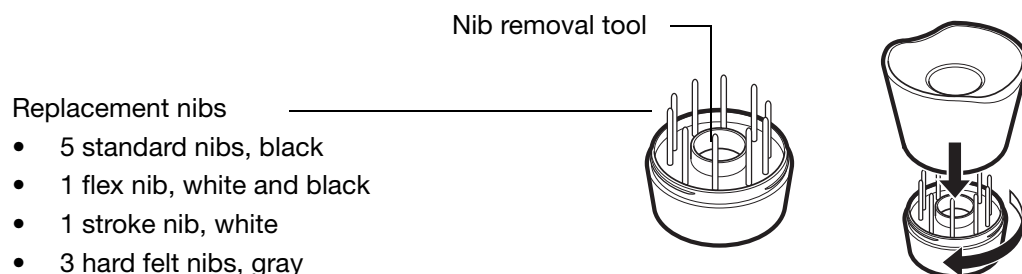

2. Clasp the old nib and pull it straight out of the pen. Use the nib removal tool, pair of tweezers, needle-nosed pliers, or similar instrument.



- Slide the end of the new nib straight into the barrel of the pen. Firmly push the nib until it stops.

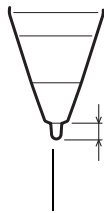

Replace nib at 1 mm (1/25 inch) or less.

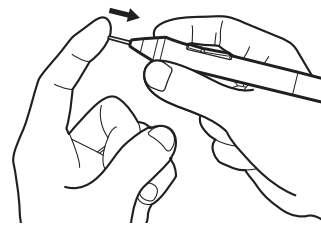
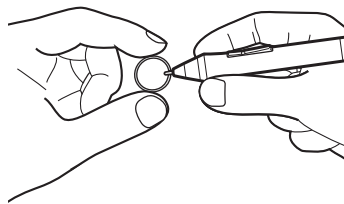

Note: Stroke nibs are spring-loaded, providing additional tactile feedback when you are working with the Intuos Pro Pen or optional Airbrush. They are installed in the same manner as a standard pen nib.



Warning: Choking hazard. Prevent children from swallowing the pen nib or side switch. The pen nib or side switch may accidentally be pulled out if children are biting on them.

Important: When not in use, place pens in the pen stand or lay them flat on your desk. To maintain the sensitivity of your Intuos Pro tools, do not store them where they will rest on the tip or eraser.

UNINSTALLING INTUOS PRO

If you uninstall the driver, your tablet will lose all functionality. Reinstall the driver to restore tablet functionality with default settings.

Windows 8:

- From the Windows 8 Start screen, right-click in the screen's bottom left corner and chose CONTROL PANEL from the pop-up menu. If you are using Windows 8 Classic Desktop, press the Windows key on your keyboard, or select the Windows icon in the Charms bar, to access the Start screen.
- Choose UNINSTALL A PROGRAM or ADD OR REMOVE PROGRAMS.
- Select WACOM TABLET and click on the REMOVE button.

Windows 7 and Vista:

- Click START and choose CONTROL PANEL.
- Click UNINSTALL A PROGRAM or ADD OR REMOVE PROGRAMS.
- Select WACOM TABLET and click on the REMOVE button.

Note: You may need to reboot your computer for the uninstall to take effect.

Mac:

- From the GO menu, choose APPLICATIONS and open the WACOM TABLET folder.
- Double-click on the WACOM TABLET UTILITY icon. Click on the TABLET SOFTWARE: REMOVE button. Enter your administrator log on name and password.
- After the removal is completed, click OK.

See for information on downloading a new software driver (when available) from the Wacom website.



INSTALLING MULTIPLE TABLETS

- Any tablet that has been detected on your system will appear as an icon within the Wacom Tablet control panel TABLET list.

Select a tablet icon for which to customize tool and application settings.

- The control panel will not launch unless a supported tablet is connected to the computer.
- Settings can only be viewed or changed for an attached tablet.

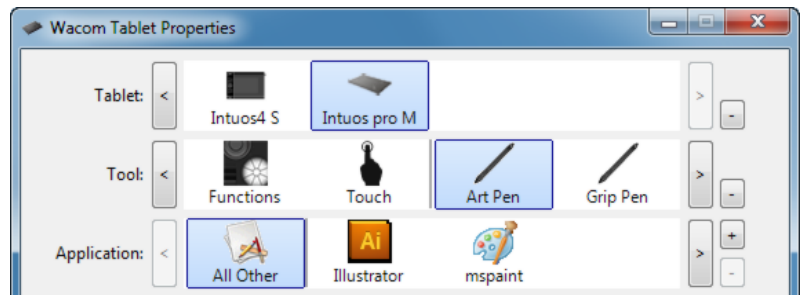

To add a new tablet, connect it to your computer. The system will automatically find the tablet and initialize it. An icon for the tablet will then appear in the control panel.

Important: When installing additional tablets on Windows systems, the eraser function may not work in some applications when using the additional tablet(s). The eraser function will continue to work correctly using the first tablet that was added to the control panel.

To remove one of multiple tablets from the driver, select the tablet to be removed and click on the [-] button next to the TABLET list.

- A tablet must be attached to the computer before it can be deleted from the control panel list.
- You will need to restart your computer before you can again add the tablet to the driver.

USING INTEGRATED APPLICATIONS

Some software applications may be designed to directly control ExpressKey or Touch Ring function(s). When working in an application that has been integrated in this manner, the ExpressKeys or Touch Ring may perform differently than the function that is set in the Wacom Tablet control panel.

- When an ExpressKey is overridden by an application, the ExpressKey setting will automatically update, using either “Application Defined” or the new function name. Some or all of the ExpressKeys may be overridden, depending on the application.
- When an application overrides the Touch Ring, all Touch Ring modes are affected. If an application overrides only some of the available Touch Ring functions, the remaining mode(s) are set to SKIP.
- An integrated application will control the ExpressKeys or Touch Ring only when that application is active and in the foreground. When you close that application or select a new application pane to work in, your Wacom Tablet control panel settings are returned to their previous state.
- To review the ExpressKey, Touch Ring, or pen settings for the current front-most application, set an ExpressKey to [SETTINGS](#) and press the key at any time.

Applications that have been integrated in this way will typically provide you with the opportunity to disable this functionality when first using your Wacom product with the application. See the documentation provided with your application for specific details how to customize or disable this feature.

If an automatic prompt or the application’s documentation does not describe how to disable this behavior, you can use the Wacom Tablet control panel to create [Application-specific settings](#) that will override the behavior of the integrated application.

Important: If an application-specific setting has been created for an integrated application, setting an ExpressKey or Touch Ring mode to APPLICATION DEFINED will still allow the integrated application to control the function.



IMPORTING EXPERT SETTINGS

The import expert settings feature enables you to import customized Wacom Tablet control panel settings that have been specified in an XML (Extensible Markup Language) file.

- Some software developers may create custom settings files which are specifically designed to provide optimum performance when using your Wacom product with their applications.
- Visit the Wacom web site for your region to choose from a variety of custom settings files that may be available for your product.
- Each XML file may include customized settings for one or more applications. These settings may apply to the ExpressKeys, Touch Ring, Radial Menu, or pen button and eraser functions.

To import expert settings:

1. Choose an XML file with settings for use with a particular application. Double-click on your file selection.
2. Carefully read and follow the instructions in the confirmation dialog.
 - The utility will import settings for one or more applications. Any previous settings for those applications may be overridden.
 - You are encouraged to back up any existing control panel settings before importing the expert settings.
 - You can cancel, or continue to import the settings.
3. When you choose to import settings, only the settings specified in the XML file will be imported. Any corresponding settings will be overridden with the new values. All other existing settings will remain unchanged.

After the import process is completed you will have an opportunity to view the new settings within the Wacom Tablet control panel.





USING THE OPTIONAL AIRBRUSH AND ART PEN

The optional Intuos Pro Airbrush works like the Grip Pen, and includes a fingerwheel for additional control. Hold the Airbrush with your thumb and middle finger. The fingerwheel should be in a convenient location for you to roll it with your index finger. Tilt the Airbrush for a comfortable position that allows you to paint and draw with pressure sensitivity.

You can simulate realistic airbrushing with the proper software support. For example, apply pressure on the tip to control the brush size. Tilt the Airbrush to elongate and feather the spray pattern. Roll the fingerwheel to adjust the spray intensity.

Side switch

Default settings:

Windows: RIGHT CLICK

Mac: DOUBLE CLICK

Fingerwheel

Roll the fingerwheel backwards to increase ink flow or brush size, and forward to reduce it.

Your index finger should operate the wheel independently of the pressure you apply to the tip.

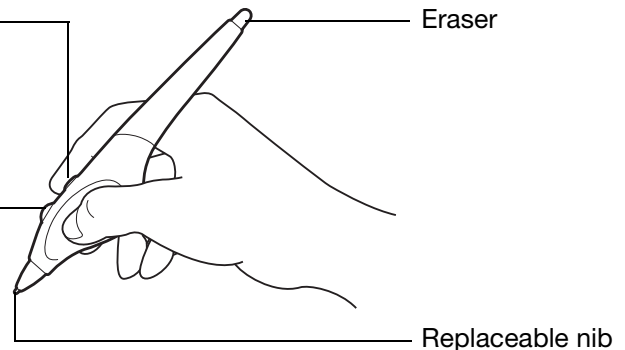

The optional Intuos Pro Art Pen responds to the pressure, tilt, and rotation you apply to the pen.

Side switches

Default settings:

Upper: DOUBLE CLICK

Lower: RIGHT CLICK

Replaceable nib

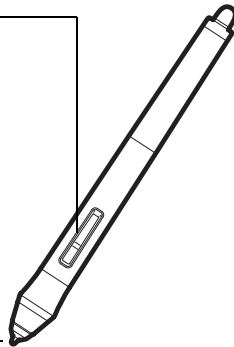

Eraser

Does not support rotation.

The Art Pen supports 360 degrees of rotation around the pen axis. As you draw within an application that supports rotation sensitivity, simply twist the Art Pen to create lines that narrow or broaden.

While painting you can vary the rotation of a non-circular brush to change the stroke thickness. Depending on the brush shape characteristics you have selected in your application, you can simulate calligraphy pens, broad felt tip markers, and any other non-circular brushes or tools.

Important: When not in use, set the Airbrush or Art Pen flat on your desk. To maintain the sensitivity of your tool, do not store it in a container where it will rest on its tip or eraser. Leaving an Intuos Pro tool on the tablet may interfere with screen cursor positioning when using other pointing devices.

See [Product information](#) to learn more about which applications currently support the Airbrush fingerwheel or Art Pen rotation. See [Ordering parts and accessories](#) for information on where to purchase an Intuos Pro Airbrush or Art Pen.



USING THE OPTIONAL MOUSE

The optional Mouse is cordless, battery free, and works on the Intuos Pro tablet.

Fingerwheel

Can be rolled, or pressed for an additional button function.

- Roll the fingerwheel to scroll in most windows and applications. Move the wheel forward to scroll up, and back to scroll down.
- Press down on the wheel to perform a MIDDLE CLICK.

Tip: For Microsoft Office applications that support a wheel mouse, press the CTRL key and move the fingerwheel to zoom in and out.

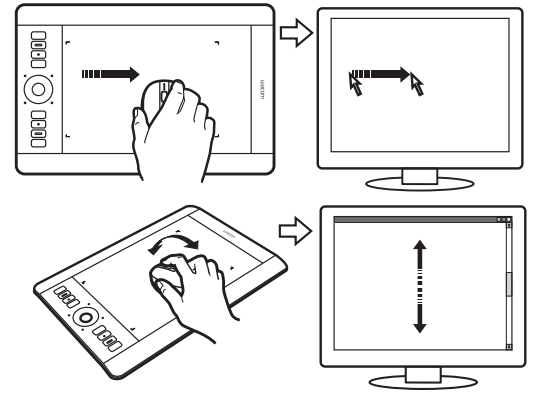

Right button

Displays a context menu when pressed.

Left button

This is the primary button used to CLICK and select.

The [mouse buttons](#) can be customized.

Default settings:

Left:	CLICK
Right:	RIGHT CLICK
Middle:	MIDDLE CLICK
Front:	FORWARD
Rear:	BACK

Front and rear buttons

These are set for FORWARD and BACK functionality within your Internet browser.

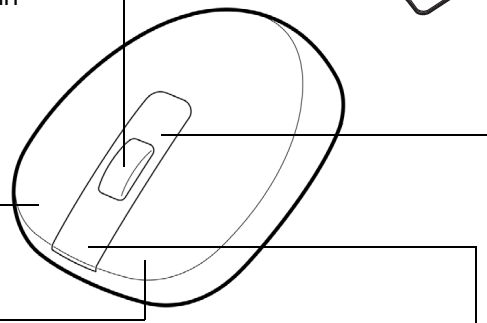

Important: When the optional mouse is not in use, place it on your desk. Leaving a tool on the tablet may interfere with screen cursor positioning when using other pointing devices, or may prevent your computer from going to sleep.

See also [Customizing the mouse](#).



CUSTOMIZING THE MOUSE

Use the optional Mouse to open the Wacom Tablet control panel. The MOUSE tool will be selected in the TOOL list. If the mouse is not automatically selected, choose it from TOOL list. Select the MOUSE tab.

Select the [functions](#) to perform when pressing a button.

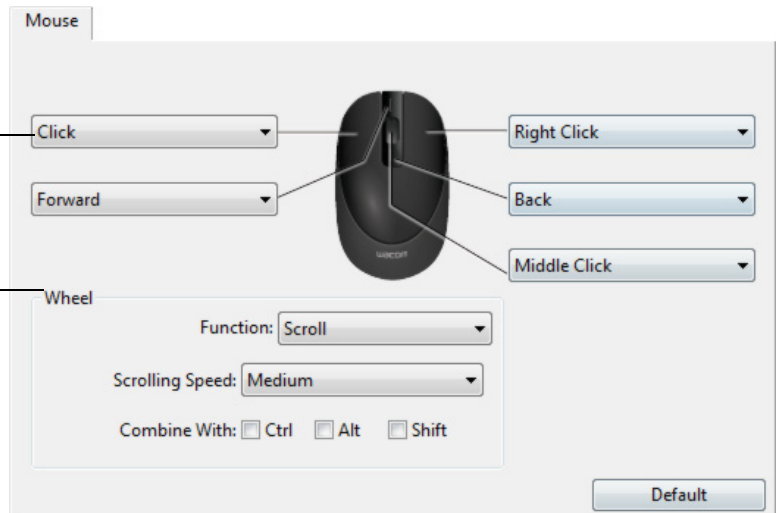

WHEEL options control the fingerwheel function.

SCROLL	<p>Default setting. When selecting SCROLL, the tab displays custom scroll options. Choose a SCROLLING SPEED to use for each notch of wheel movement.</p> <p>When you select one or more COMBINE WITH: modifier key options, the selected option(s) will be sent to the application along with each scroll action. For example, you can create custom zooming or other actions within an application.</p> <p><u>Mac</u>: The available options are OPTION, COMMAND (Apple key), CONTROL, and SHIFT.</p>
KEYSTROKE	<p>Assign custom functions to the fingerwheel by selecting KEYSTROKE. This is useful when working with repetitive functions. Keystroke(s) that you define are sent once for each notch of wheel movement.</p> <p>To double the speed of a keystroke action, enter the keystroke sequence twice within the DEFINE KEYSTROKE dialog box.</p>
DISABLED	Disables the wheel function.

The mouse buttons are chordable. You can press two or more buttons simultaneously. For example, if you customize one button to simulate the CTRL key and another to simulate an ALT keystroke, when you press both buttons a CTRL+ALT is simulated.

Note: To configure the Mouse for left-handed use, simply reassign the button functions as needed. You can also open the Wacom Tablet control panel, click on OPTIONS... and select LEFT in the MOUSE HANDEDNESS group.





MOUSE MODE options on the MAPPING tab determine how the tool will track when the optional mouse is available in the TOOLS list.

MOUSE TRACKING options apply only to the optional Mouse for Intuos pro.

- When USE TABLET ORIENTATION is selected, moving the mouse toward the top of the tablet moves the screen cursor up. In this mode the entire active area of the tablet is available for mouse tracking.
- When USE MOUSE ORIENTATION is selected, moving the mouse forward moves the screen cursor up. In this mode a reduced inset portion of the active area is available for mouse tracking. This is the default setting for the Intuos pro tablet.

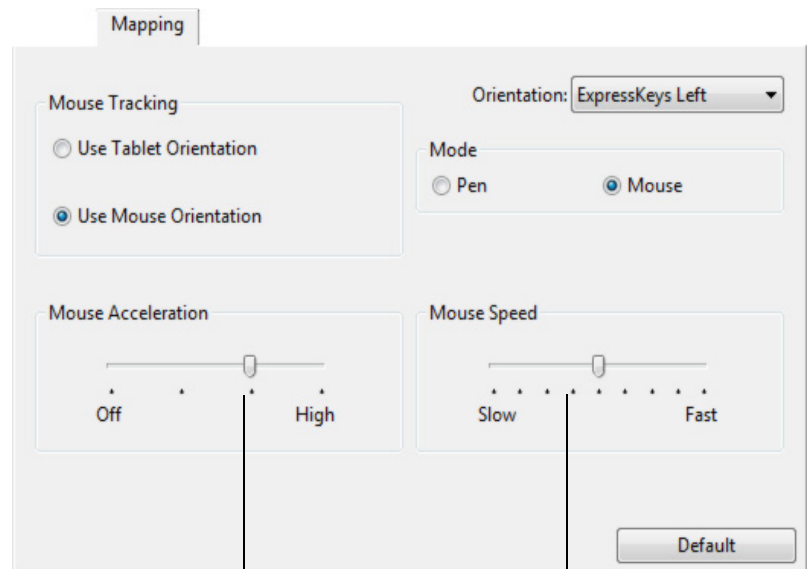

Sets the screen cursor acceleration

Select a slower or faster screen cursor tracking speed.

Notes:

You can switch between pen mode and mouse mode using the [Radial Menu](#).

If you frequently switch between pen mode and mouse mode, you can assign the [MODE TOGGLE...](#) function to one of your tool buttons.





TESTING THE MOUSE

1. Use the Wacom Tablet control panel to open the DIAGNOSTICS dialog box. See [Testing the tablet controls and tools](#).
2. With the DIAGNOSTICS dialog box open, place the Mouse on the tablet active area and test by clicking each mouse button. A tablet status LED should brighten and the SWITCHES state should change for each button you click.

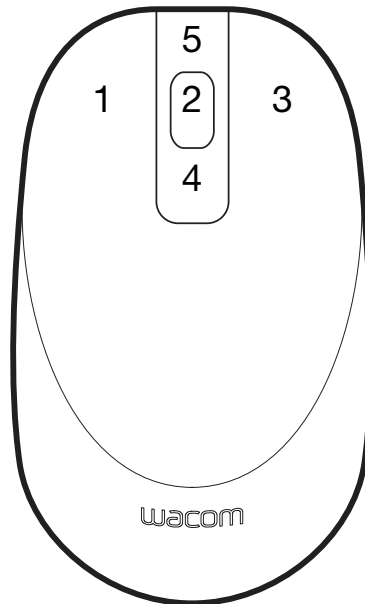

3. When the DIAGNOSTICS dialog box is first opened the WHEEL status should be 0. Move the fingerwheel backward. The WHEEL status should change from 0 to +1.
4. Move the fingerwheel forward. The WHEEL status should change to -1.
5. When done, click CLOSE to exit the dialog box.





PEN AND DIGITAL INK CAPABILITIES IN WINDOWS

Microsoft Windows provides extensive support for pen input. Pen features are supported in all versions of Windows except Windows 7 Starter and Home Basic, and Windows Vista Home Basic.

- **Note taking.** Jot notes and capture quick sketches in Windows Journal. Use the Journal search engine to locate your handwritten content.
- **Handwriting recognition.** Quickly enter handwritten information anywhere the computer accepts typed input. Convert your handwritten content to typed text at any time.
- **Gestures.** Make simple gestural movements on the tablet to trigger customizable actions. To customize gestures, select the FLICKS tab in the Windows 8 or Windows 7 PEN AND TOUCH or Windows Vista PEN AND INPUT DEVICES control panel.
- **Digital Ink in Microsoft Office 2007 or later.** Utilize the enhanced digital mark-up and inking tools found on the REVIEW tab within applicable applications.

The Windows Input Panel enables you to use handwriting or an on-screen keyboard to directly enter text with your Wacom pen.

There are different ways to launch the Input Panel:

- Click on the Input Panel icon which appears when you move the screen cursor into a text entry area.
- Click on the Input Panel tab, located by default on the left edge of the display screen.
- Click on the Tablet PC Input Panel icon located on the Windows Taskbar. If the icon is not visible, right-click on the Taskbar, select TOOLBARS, and TABLET PC INPUT PANEL.

To disable the Input Panel:

1. Open the Tablet PC Input Panel.
2. Select TOOLS and OPTIONS.
3. Choose the OPENING tab and uncheck the following boxes:
 - FOR TABLET PEN INPUT, SHOW THE ICON NEXT TO THE TEXT BOX
 - SHOW THE INPUT PANEL TAB.
4. Click OK.

For details, study the documentation that came with your system, including the Windows training tools and Tablet PC tutorial. To access the Tablet PC Pen Training, from the START menu choose ALL PROGRAMS, TABLET PC, and TABLET PC PEN TRAINING. Search the Windows help system for training tools if they are not available from the START menu.

See the Microsoft web site for enhanced information about digital inking in Windows. You can also visit the Wacom web site at <http://wacom.com> and search digital inking in Windows.

Note: The following workarounds in the Wacom software driver improve performance in Windows 7 and Vista:

- The Pen Flicks and 'press-and-hold-to-right-click' features are disabled in graphics applications using the Wintab API.
- There is no pressure sensitivity in Journal and other Ink features when both the Flicks and 'press-and-hold-to-right-click' features are disabled in the PEN AND TOUCH or PEN AND INPUT DEVICES control panel.





PRODUCT INFORMATION

To learn more about Intuos Pro, visit the Wacom web site for your region. You can also discover which software applications are currently tablet enhanced to support the pressure sensitivity and other special functionality of your tablet by searching software applications.

USA, Canada, Central and South America	https://store.wacom.com/us
Europe, Middle East and Africa	http://wacom.eu
Japan	http://tablet.wacom.co.jp
Asia Pacific (English)	http://wacom.asia
China (Simplified Chinese)	http://wacom.com.cn
Korea	http://wacom.asia/kr
Taiwan	http://wacom.asia/tw
Thailand	http://wacom.asia/th

ORDERING PARTS AND ACCESSORIES

Your Intuos Pro Pen tablet is the ultimate master tool for creative professionals. The tablet, combined with the Intuos Pro Pen and other available tools, enables you to paint more intuitively, illustrate more skillfully, and edit imagery faster than ever before.

To purchase parts and accessories, refer to the Wacom Store site for your region.

You can also do the following:

- In the USA or Canada, call 1.888.884.1870 (toll-free) or visit Wacom's web site at <https://store.wacom.com/us> (USA only).
- In Europe, call +49 (0)180.500.03.75 or send an email to spareparts@wacom.eu. Or, visit <http://shop.wacom.eu>. You can also contact your local dealer, distributor, or technical support using the appropriate number for your region.
- In Japan, visit <http://store.wacom.jp>. You may also contact your local dealer, distributor, or technical support using the appropriate number for your region.
- In Australia, Singapore, Taiwan and Korea, please visit: <http://BuyWacom.com.au>; BuyWacom.com.sg; BuyWacom.com.tw; and BuyWacom.co.kr, respectively.
- In other countries, please contact your local dealer or distributor.

Some parts and accessories may not be available in all regions.





WARRANTY SERVICE

The full product warranty and licensing agreement is provided in the Important Product Information document included on your product CD.

WARRANTY SERVICE IN THE U.S. AND CANADA

To obtain Warranty service within the U.S. or Canada contact:

Wacom Support Center

Phone: 1.360.896.9833

Email Inquiry form: <http://wacom.us/en/contact-support>

WARRANTY SERVICE OUTSIDE OF THE U.S. AND CANADA

For products purchased or used outside the United States and Canada, the warranty period may be determined by regional requirements. The warranty period for your pen display is described on the Support page of the Wacom web site for your region, or contact Wacom Support.

Wacom Technical Support in Asia Pacific (except Japan and China)

Detailed Asia Pacific Limited Warranty policy and product registration may be found online at <http://wacom.asia>.

To obtain technical support or Warranty service within Southeast Asia, Oceania and Taiwan, please contact Wacom Customer Support Service for your region.

Phone numbers can be found at: <http://wacom.asia/customer-care>.

Should you have any questions about this Agreement, or if you want to contact Wacom, please write to:

IN NORTH AND SOUTH AMERICA CONTACT:

Wacom Technology Corporation
1311 SE Cardinal Court
Vancouver, Washington 98683
U.S.A.

IN JAPAN CONTACT:

Wacom Co., Ltd.
Sumitomo Fudosan Grand Tower 31F
8-17-1 Nishi-shinjuku, Shinjuku-ku
Tokyo, 160-6131, Japan

IN ASIA PACIFIC CONTACT:

Wacom Co., Ltd.
Asia Pacific Office
Sumitomo Fudosan Grand Tower 31F
8-17-1 Nishi-shinjuku, Shinjuku-ku
Tokyo, 160-6131, Japan

IN MAINLAND CHINA (EXCEPT HONG KONG) CONTACT:

Wacom China Corporation
1103 Beijing IFC West Tower
No. 8 Jianguomenwai Street
Chaoyang District
Beijing, 100022, China
E-mail: support@wacom.com.cn





GLOSSARY

Active area. The navigation and drawing area of the tablet where touch or your Intuos Pro tools are detected. See [touch sensor](#).

Application-specific settings. Intuos Pro tool and tablet settings that have been customized for individual applications. These can be customized by the user in the Wacom Tablet control panel, or set automatically when applications with pre-set defaults are in use. [Application-specific settings](#) are in effect whenever you use the application.

Aspect. The ratio between the vertical and horizontal dimension of the tablet or display.

Click force. The amount of force you must apply to the pen tip for a click to occur.

Digital Ink. A broad category that typically describes handwritten content which has been created using pen-based input on a computer. This handwritten content takes the form of sketches, ink mark-up, or handwriting. The handwriting can optionally be converted to typewritten text or simply left alone for use in its original format. Depending on your system and applications settings, the handwritten text you make with digital ink can be converted on-the-fly or at another time.

Display Toggle. An Intuos Pro feature that allows you to work with your tablet on all displays or on one display at a time. Available only on multiple monitor systems. See [working with Display Toggle](#).

Double-click assist. A function of the Wacom Tablet control panel that makes it easier to double-click by setting the size of the double-click distance.

Double-click distance. The maximum distance (in screen pixels) that the screen cursor can move between clicks and still be accepted as a double-click. Increasing the double-click distance makes double-clicking easier, but may cause a delay in brush strokes in some graphics applications.

Double-click speed. The maximum time that can pass between clicks and still be accepted as a double-click.

Eraser-aware application. A software application that has built-in support for the pen eraser. These applications take advantage of the eraser in different ways, depending on what makes sense for the application.

Expand. A motion used when [Navigating with touch](#). Touch the tablet with two fingers spaced closely together. Then while still touching the tablet surface, move your fingers apart.

ExpressKeys. The customizable control keys located on your Intuos Pro tablet. See [using the ExpressKeys](#).

ExpressKeys Left. A tablet setting where the Touch Ring and ExpressKeys are oriented to the left of the tablet.

ExpressKeys Right. A tablet setting where the Touch Ring and ExpressKeys are oriented to the right of the tablet.

Fingerwheel. The control wheel on the optional Intuos Pro Airbrush.





Journal. A Microsoft Windows application that electronically simulates a physical journal pad, but with the advantages of digital note taking. For example, you can create quick sketches and jot handwritten notes that can be converted to text and sent on to colleagues for digital mark-up. Journal includes a variety of pen, marker, and highlighter tools, plus an eraser that is easily activated by the eraser end of your Wacom pen. Additionally, your handwritten content is searchable within Journal.

LED. Light-Emitting Diode. Used as tablet indicator light(s).

Mapping. The relationship between the tool position on your Intuos Pro tablet and the cursor position on the monitor screen.

Modifier. Modifier keys include SHIFT, ALT, and CTRL for Windows, or SHIFT, CONTROL, COMMAND, and OPTION for Mac. You can customize your Intuos Pro tool buttons or ExpressKeys to simulate a modifier key.

Mouse acceleration. A setting that allows you to adjust the screen cursor acceleration when using mouse mode.

Mouse mode. A method for positioning the screen cursor. When you place an Intuos Pro tool on the tablet, you can move the screen cursor with a “pick up and slide” motion similar to using a traditional mouse. This is known as relative positioning, and is the default setting for the optional Mouse. See also [pen mode](#).

Mouse speed. A setting that allows you to adjust the speed at which your screen cursor moves when using mouse mode.

Nib. The replaceable pen tip.

Pairing. A method of creating a virtual cable link between two devices.

Pan. A motion used when [Navigating with touch](#). Touch the tablet surface with your fingers and move them in the same direction.

Pen input. A method of controlling a computer using the pen tool on your Intuos Pro tablet.

Pen mode. A pen input method of positioning the screen cursor. Wherever you place your pen tool on the tablet, the screen cursor will jump to the corresponding point on the screen. This is known as absolute positioning, and is the default setting for Intuos Pro Pen tools. Pen mode allows you to quickly position the screen cursor without having to first find it and then move it across the desktop. See also [mouse mode](#).

Pinch. A motion used when [Navigating with touch](#). Touch the tablet with two fingers spaced slightly apart. Then while still touching the tablet surface, move or ‘pinch’ your fingers together.

Pixel. The smallest unit of measure on your monitor screen.

Pressure sensitive. A quality of the Wacom pen tip and eraser that senses the amount of pressure being applied. This is used to create natural-looking pen, brush, and eraser strokes in applications that are pressure sensitive.

Pressure-sensitive application. Any application that supports pressure-sensitive input.

Proximity. The height above the tablet [active area](#) where pen detection occurs. See also [Using the side switch](#).

Radial Menu. A hierarchical menu (in radial format). Each level of the menu consists of eight menu slices which may contain various features and options to choose from. You can customize the buttons of your pen or tablet to display this menu.

Rotate. A motion used when [Navigating with touch](#). Touch the tablet with two fingers spaced slightly apart and move (rotate) them in a circular fashion, or move them in opposing directions. Alternatively, hold one finger stationary and track your other finger around the stationary finger.

Screen cursor. The pointer on the display screen. Screen cursors come in different shapes (such as an I-beam, arrow, or box), depending on which application you are running.





Swipe. A motion used when [Navigating with touch](#). Touch the tablet surface with three, four, or five fingers and move them in the same direction.

Tablet PC Input Panel (TIP). The Microsoft Windows Tablet PC Input Panel enables you to use your Wacom pen to create handwritten notes or work with an on-screen keyboard. The Input Panel dynamically converts your handwriting to text. Information you create can then be inserted into other documents, spreadsheets, or illustrations.

Tap. A motion used when [Navigating with touch](#). Touch and lift a single finger (or multiple fingers, depending on the gesture) from the tablet.

Tilt sensitive. A quality of the pen tip and eraser that senses the amount of tilt between the tool and tablet. This is used to create natural-looking pen, brush, and eraser strokes in applications that are tilt sensitive.

Touch. A method of interacting with a computer using only your fingers on the Intuos Pro tablet. May also be referred to as “touch input”.

Touch Ring. The customizable control ring located on your Intuos Pro tablet. See [using the Touch Ring](#).

Touch sensor. The navigation area of your Intuos Pro tablet where touch is detected. The touch sensor resides within the active area, and does not accept pen input.

Track. A motion used when [Navigating with touch](#). Touch and move a single finger across the tablet surface.

USB. Universal Serial Bus. A hardware interface standard for connecting computer peripheral devices. USB ports support hot-plugging, which allows you to disconnect a USB device without turning off your computer.

Wintab. An interface standard used by Windows applications for receiving tablet information. Intuos Pro supports all Wintab-compatible applications under Windows.





INDEX

About the manual	5	advanced	31
Accessories and parts		customizing	31
ordering	91	Expert settings, importing	84
Active area, understanding	13	Express View display	20
Adding a new tool	51	ExpressKeys	
Airbrush		customizing	33
holding	85	testing	69
replacing the tip	81	using	18
using	85	Features	
Application-specific settings	49	control panel	14, 22
creating	50	pen	9
removing	50	pen stand	9
Art Pen, using	85	Force proportions	35
Button functions	39	Functions, button	39
Care and maintenance	80	General problems, troubleshooting	71
Control panel		Holding	
features	14, 22	Airbrush	85
lists	23	pen	16
tabs	23	Information, product	91
Controls, testing	68	Installing multiple tablets	83
Customizing	28	Intuos pro	
double-click	30	about your tablet	6
eraser feel	31	setting up	10
advanced	31	the touch experience	24
ExpressKeys	33	using	15
mouse		Mac-specific problems, troubleshooting	78
buttons	87	Maintenance and care	80
fingerwheel	87	Manual, about	5
pen	29	Mapping, to multiple monitors	14
Radial Menu	46	Mouse	
tablet		buttons, customizing	87
ExpressKeys	33	fingerwheel	
Touch Ring	34	customizing	87
tablet to screen mapping	35	using	86
tip feel	30	testing	89
advanced	31	using	86
tool buttons	32	Mouse mode	88
touch		Multiple	
custom functions	27	monitors	
Touch Ring	34	mapping to	14
Diagnostics	68	working with	14
Display Toggle, working with	47	tablets, installing	83
Double-click, customizing	30	Navigation, customizing for touch	26
Driver downloads, obtaining	80	New tool, adding	51
Eraser feel		Nib, replacing	81





Options, advanced	52	testing	69
Ordering parts and accessories	91	using	21
Orientation, configuring for tablet	12	working with	18
Parts and accessories		Tablet to screen mapping, customizing	35
ordering	91	Technical Support, contacting	80
Pen		Testing	
customizing	29	controls	68
features	9	ExpressKeys	69
holding	16	mouse	89
positioning with	17	pen	70
pressure sensitivity, working with	17	tablets	66
replacing the tip	81	tools	68
side switch	18	Touch Ring	69
testing	70	Tip feel	
tip, replacing	81	advanced	31
Pen mode	35, 36	customizing	30
Pen problems, troubleshooting	72	Tool buttons, customizing	32
Pen stand, using	16	Tools	
Pens, optional	29	testing	68
Positioning, with pen	17	working with multiple	51
Preferences, managing tablet	53	Touch	
Pressure sensitivity, working with	17	adjusting touch speed	26
Product information	91	basic actions	25
Radial Menu		custom touch functions	27
customizing	46	customizing	25
using	46	gestures	25
Removing application-specific settings	50	navigating with	25
Requirements, system	6	options	25
Screen area, portion of	37	setting navigation features	26
Settings		speed, adjusting	26
application specific	49	the experience	24
creating application specific	50	Touch problems, troubleshooting	74
removing application specific	50	Touch Ring	
Set-up	10	customizing	34
Side switch, using	18	testing	69
Software		using	21
driver downloads	80	Troubleshooting	
uninstalling	82	general problems	71
System requirements	6	Mac-specific problems	78
Tablet		pen problems	72
area, portion of	38	tables	71
ExpressKeys		testing controls	68
customizing	33	testing tools	68
testing	69	touch problems	74
using	18	Windows-specific problems	77
mode options, changing	51	wireless connection problems	74
orientation, configuring	12	Uninstalling software	82
preferences, managing	53	USB cable, connection	10
testing	66	Using	
Touch Ring		Airbrush	85
customizing	34	Art Pen	85
		ExpressKeys	18





mouse	86
Radial Menu	46
touch	24
Touch Ring	21
Windows-specific problems, troubleshooting	77
Wireless operation	54
battery	
charging	58
life	61
management	58
replacement	62
components	54
connection problems	74
establishing a connection	56
optimizing the connection	57
power management	58
power saving	60
setup	55
status	
battery	59
connection	59
testing the wireless connection	64
wireless module, removal from tablet	63
wireless receiver, storage in tablet	63

